

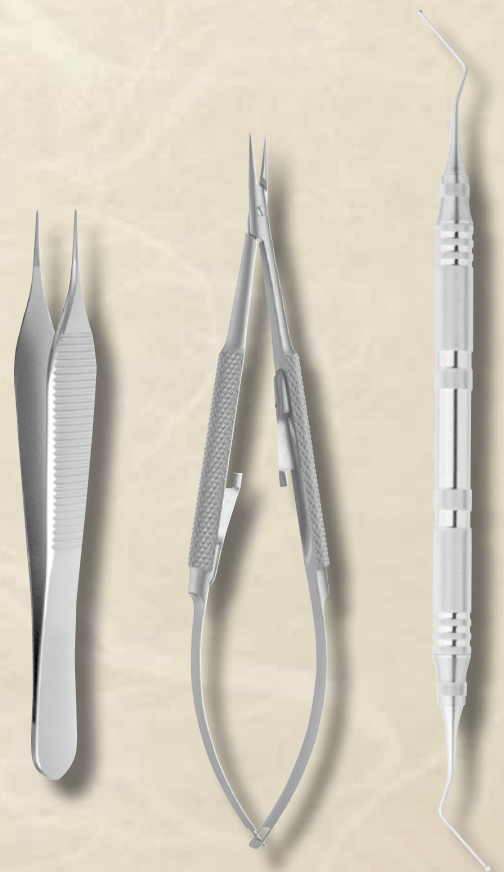

Micro

Needle Holder	114 • 117
Gum Scissors	115 • 118
Tissue Pliers	116 • 119
Root Canal Instrument	121
Periosteal Elevator	123
Mirror	123
Blade Breaker	124





*Length is 180mm ,which is comfortable for microscope use.
*This feature can prevent the fingers from coming into sight.



Needle Holder MDS-180



Size / 180mm

Suture / from 6-0 to 8-0
Suture needle / from ϕ 0.14 to ϕ 0.33mm



0.8mm

Str.
No. 32401



0.8mm

Cvd.
No. 32402

Gum Scissors MDS-180

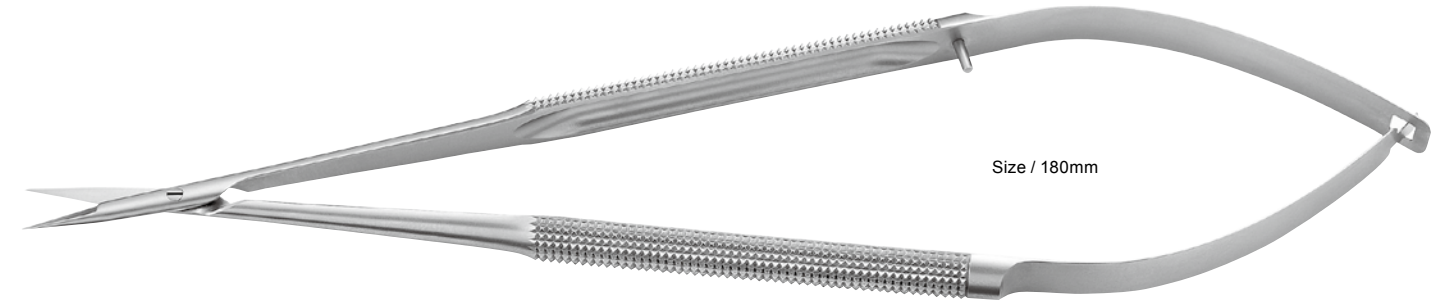

Size / 180mm



Str.
No. 32411



Cvd.
No. 32412

*Handle is designed to be round shape.
So this excellent feature allows to operate rotary by fingers.

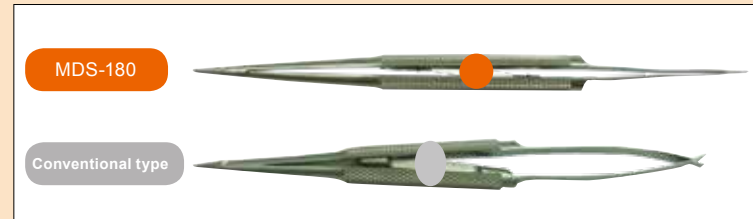

MDS-180

Conventional type



Micro Tissue Pliers MDS-180

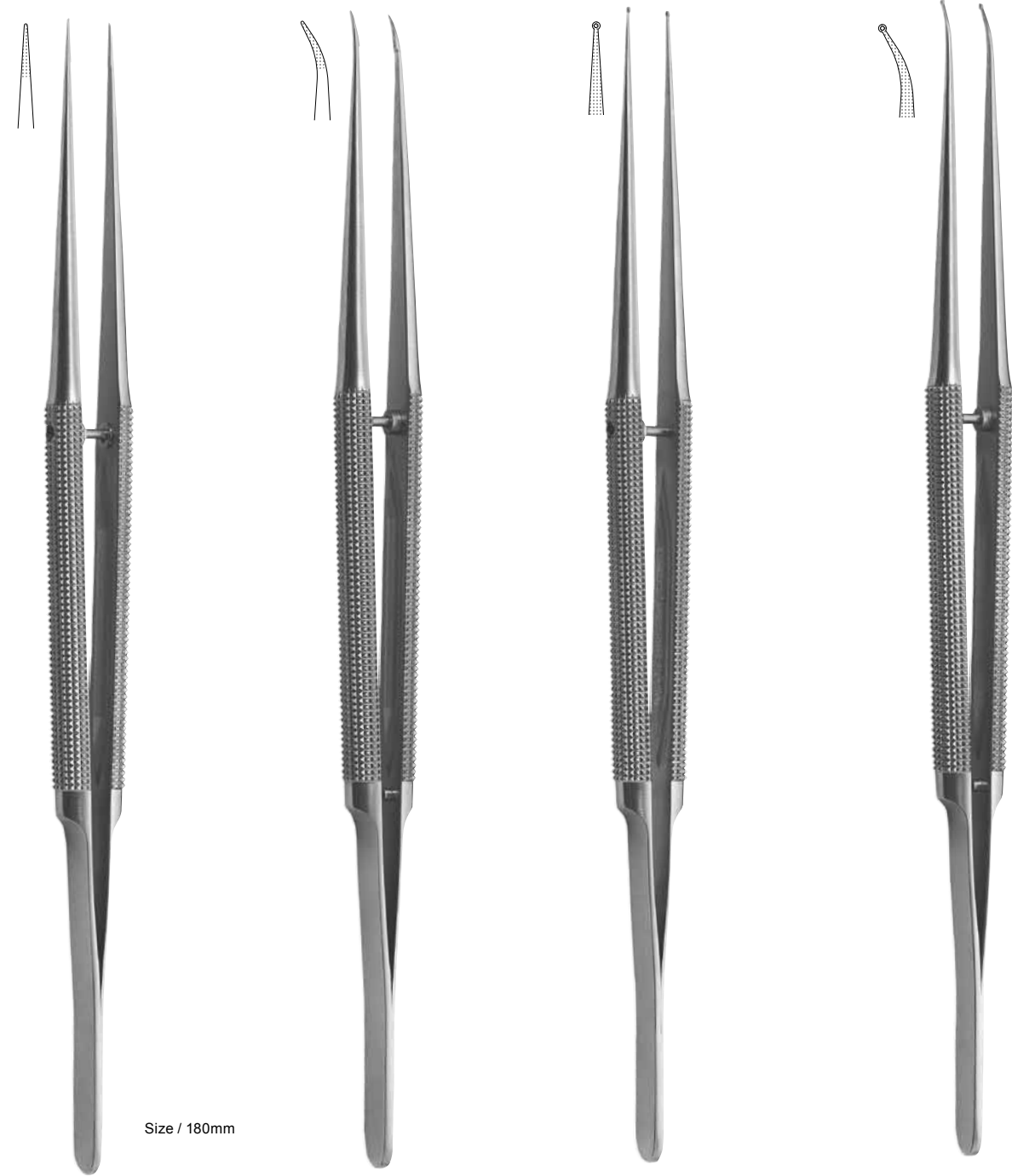

Size / 180mm

Str.
No. 32421

Suture / from 6-0 to 8-0

Cvd.
No. 32422

Suture / from 6-0 to 8-0

with Ring Str.
No. 32423

with Ring Cvd.
No. 32424

The precision of the tip



*Holding parts close horizontally and equally as surface-hold, not unequally like pint-hold. Therefore, you can surely hold delicate tissue and suture thread with this pliers.

Holding power and stability



*T/C is applied with tip part, which increases holding power of the Micro Tissue Pliers.

Comfortable control

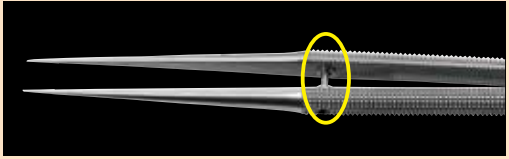

*Stopper, attached on the handle, always keeps the ideal distance. It prevents you from excessively opening and closing the pliers.



Micro Needle Holder

-MS-150 with Ratchet-

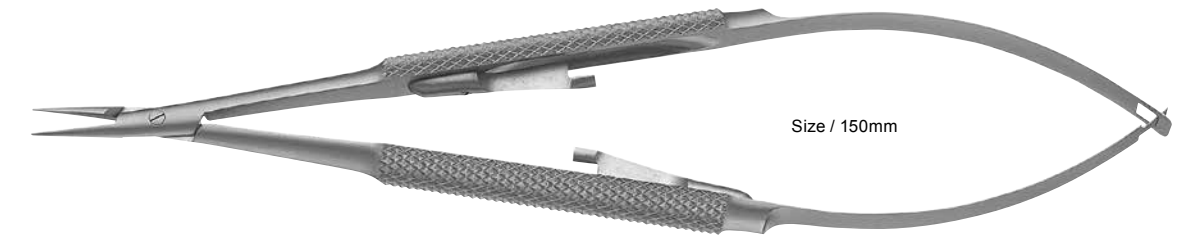

Size / 150mm

Suture / from 6-0 to 8-0
Suture needle / from ø0.14 to ø0.33mm



Str.
No. 32003



Cvd.
No. 32004





Micro Gum Scissors

-MS-150 Round handle-

*Rounded handle provides fine control of the tip.

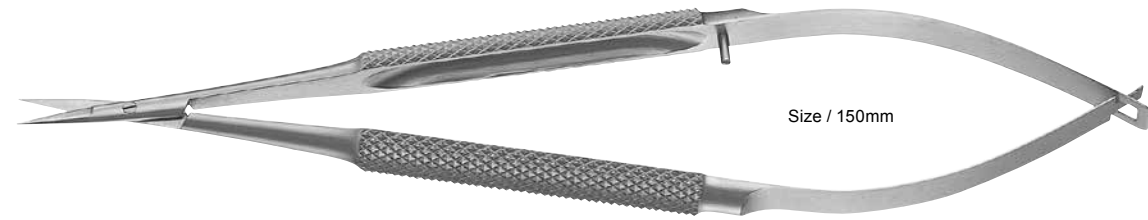

Size / 150mm



Str.
No. 32131



Cvd.
No. 32132



Micro Tissue Pliers

*Rounded handle provides fine control of the tip.

-MS-150 S-

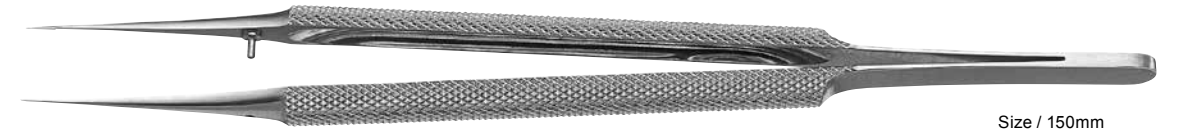

Size / 150mm

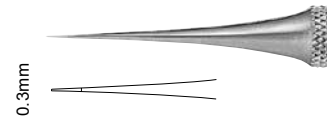

Str.
No. 32201

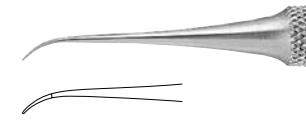

Cvd.
No. 32202



-MS-150 L-

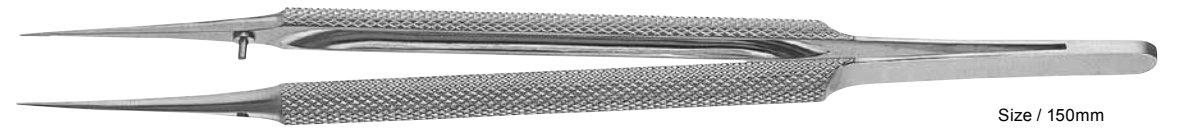

Size / 150mm

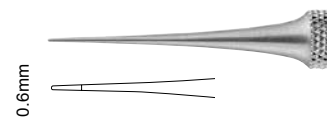

Str.
No. 32203

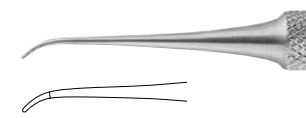

Cvd.
No. 32204



Tissue Pliers

-Micro Adson S-



Size / 120mm

with Hook

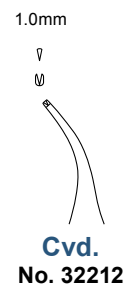

without Hook

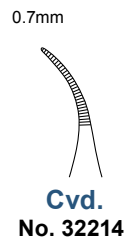

-Micro Adson L-



Size / 150mm

with Hook

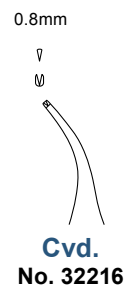

without Hook

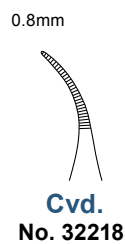

MTA Tweezers

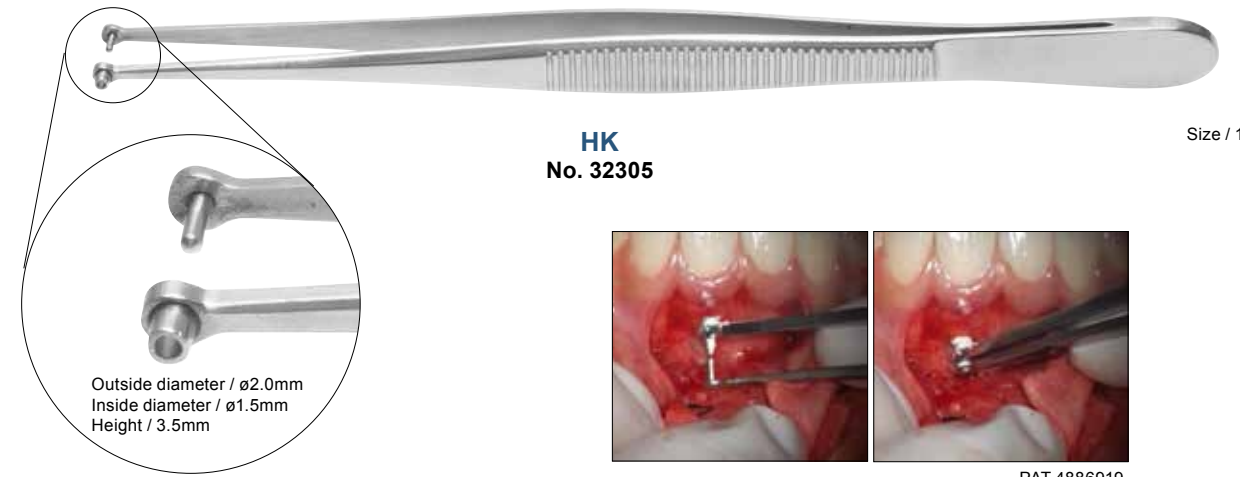

HK
No. 32305

Size / 150mm

Outside diameter / \varnothing 2.0mm
Inside diameter / \varnothing 1.5mm
Height / 3.5mm

PAT.4886919

Micro Root Canal Plugger

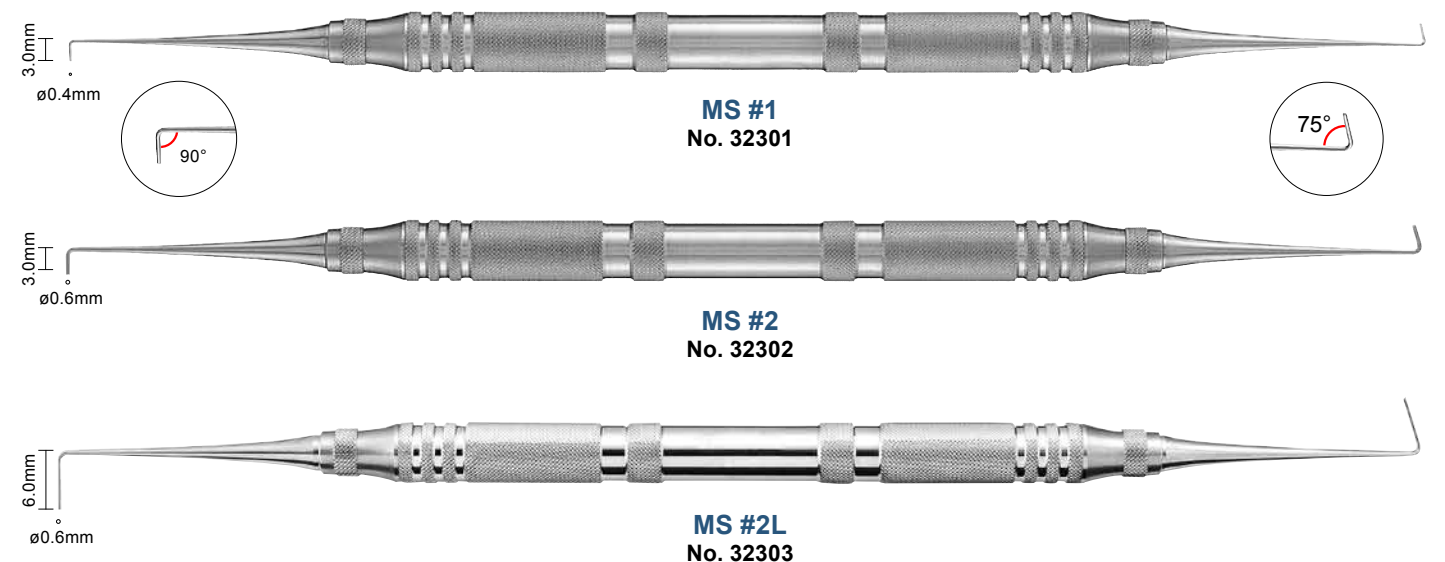

MS #1
No. 32301



MS #2
No. 32302

MS #2L
No. 32303





Micro Burnisher



MS #1
No. 32311

Micro Explorer

*Effective in diagnosis in a bone cavity.



MS #1P
No. 32351

Micro Curette



MS #1
No. 32321

MS #1 Long Neck
No. 32325

MS #2 Long Neck
No. 32326

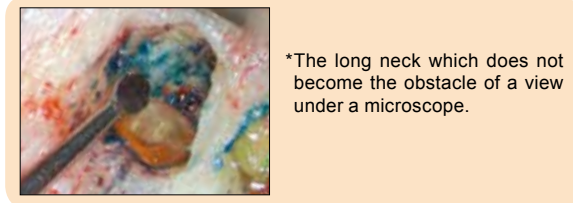

Micro Periosteal Elevator

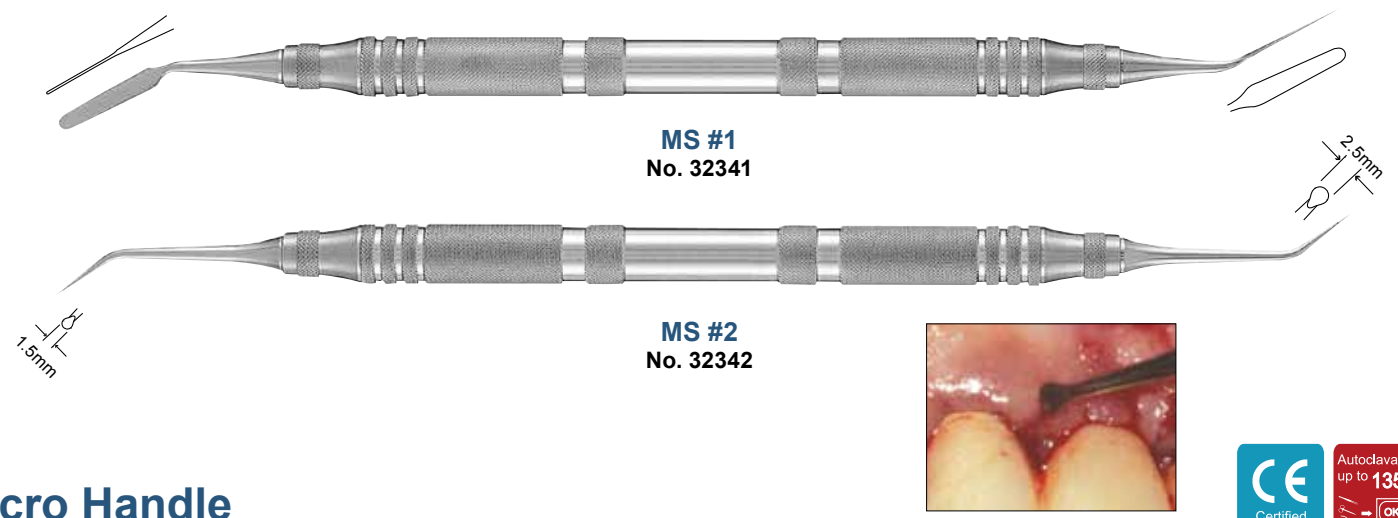

MS #1
No. 32341

MS #2
No. 32342

Micro Handle

*Handles for the mirror or scalpel for micro surgery in Periodontics and Implantology.
*Easy detachable by twisting the end of the handle.

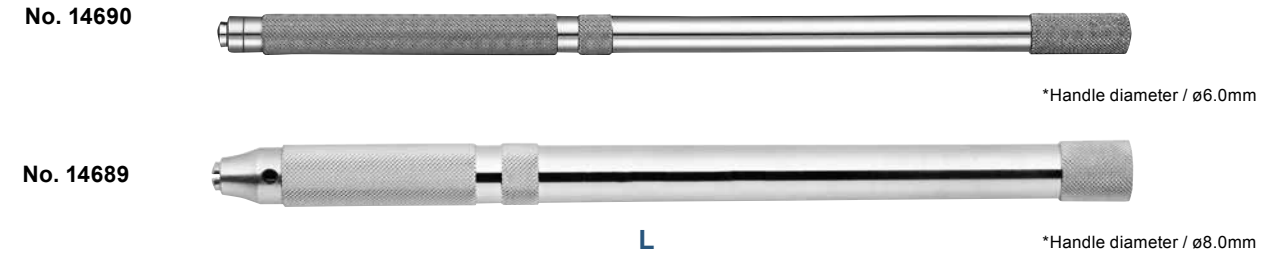

No. 14690

No. 14689



Micro Mirror Type-2

*Direct reflection type stainless mirror.
*Used with "Micro Handle"

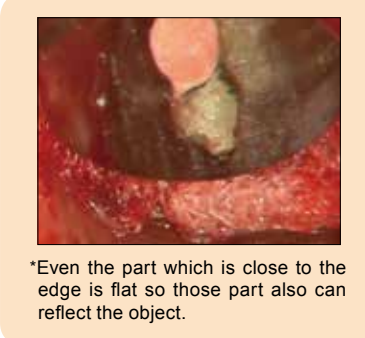
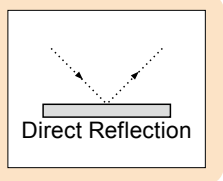
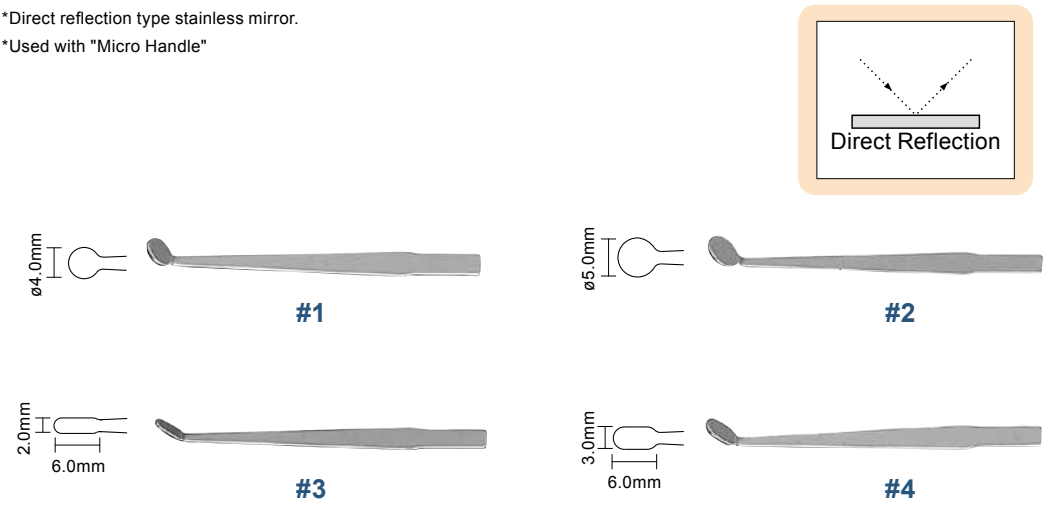

No.	Description
14901	#1 (5 ea.)
14902	#2 (5 ea.)
14903	#3 (5 ea.)
14904	#4 (5 ea.)



Blade Breaker



No. 32361



Size / 120mm



*Hold the ophthalmic scalpel and break it as appropriate size.

Lock-handle mechanism holds the scalpel stably and can be used as a scalpel holder.

