



## Other Chair-side Products

Mouth Gag	200
Cheek Retractor	201
Photographic Product	205
Bur Stand	209
Cotton Box / Phial Stand	212
Sterilization Case	216
General Tweezers	221
Instruments Stand	221
Color Tape / Color Ring	222
Cleaning Brush / Wire	223





## Mouth Prop

-with Tongue Guard-

**Contents** Mouth Prop / Tongue Guard Right, Left

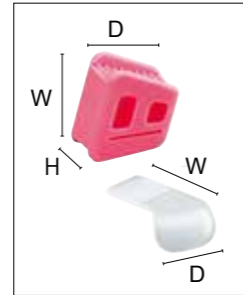

\*Prop the mouth open and depress the tongue simultaneously.

Description	Size (mm)			
	W	D	H	
Mouth Prop	L	40	35	17
	S	35	29	16
	SS	30	25	16
Tongue Guard	L / S	52	34	-
	SS	39	24	-

\*Material / Si (Main body)  
PP (Tongue Guard)

## Almighty Mouth Gag

**Contents** Main body, Tip (4 ea.)



\*Bite pressure / up to 1400N  
\*Material / Si (Tip)

**Child**  
No.14670

## Cheek Retractor

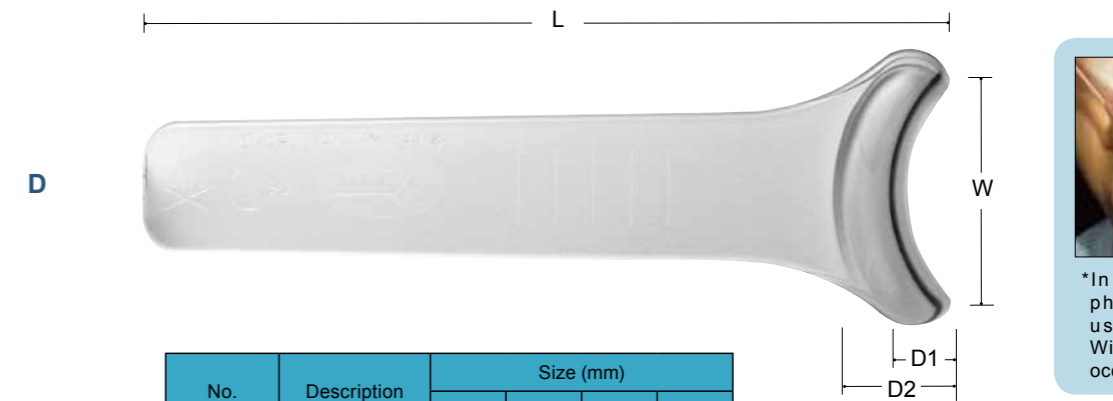
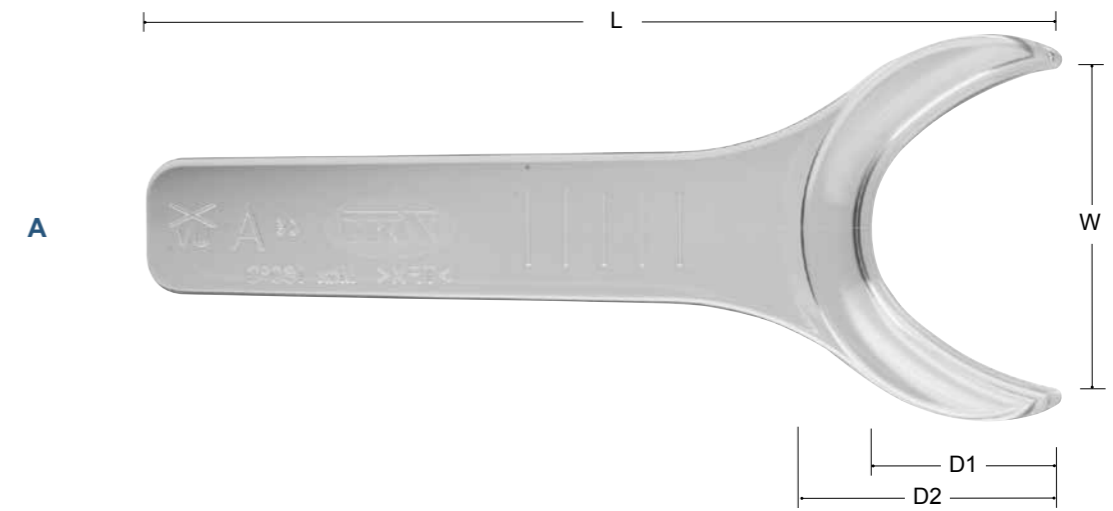

No.	Description	Size (mm)			
		W	D1	D2	L
22731	A (2 ea.)	42	25	35	120
22732	B (2 ea.)	34	17	27	120
22733	C (2 ea.)	15	-	-	74.3
22734	D (2 ea.)	28	6	16	108

\*Material / TPX

\*In the case of occlusal photography, possibly used as lip retractor. With photographic mirror occlusal.



## Cheek Retractor

### -Pigeon-

\*Easily holding by patient.

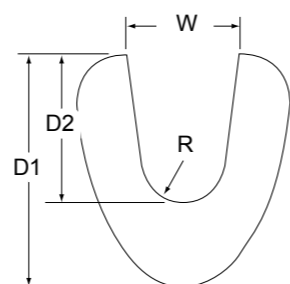

No.	Description	Size (mm)			
		W	D1	D2	R
22739	Pigeon M	30	50	32	R10
22740	Pigeon S	24	50	32	R9
22741	Pigeon SS	24	43	28	R7

\*Material / TPX

### -Anglewider-

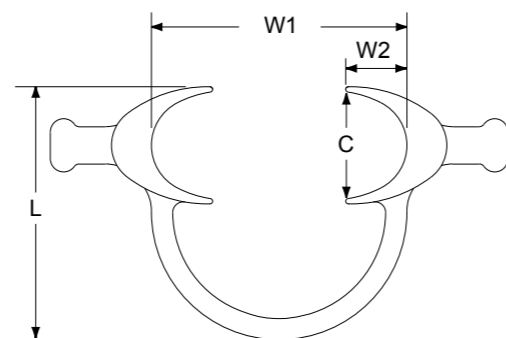
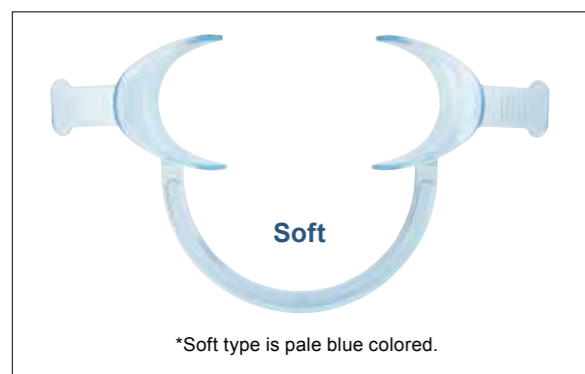

No.	Description	Size (mm)			
		W1	W2	L	C
22745	Anglewider (2 ea.)	96	23	95	40
22729	Anglewider Soft (2 ea.)				

\*Material / TPX

### -Anglewider-

\*It opens corners of the mouth, and allows clear views without auxiliary personnel.  
 \*The inner wings retract buccal mucosa, and thereby oral vestibule is clear.

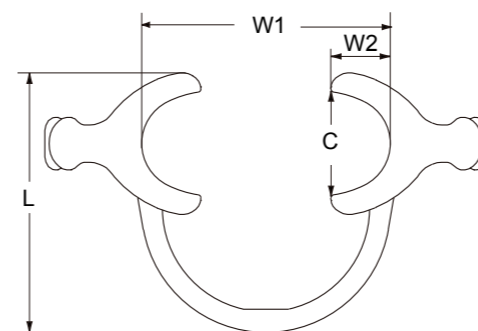

\*Material / TPX

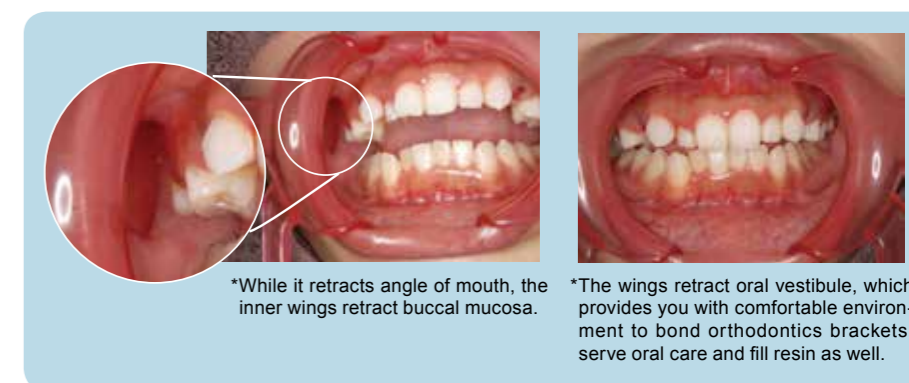

\*It opens corners of the mouth, and allows clear views without support.  
 It is absolutely convenient for taking a photo of mouth, serving oral care, doing orthodontics treatment.  
 \*It is in size for infants to lower elementary school kids.

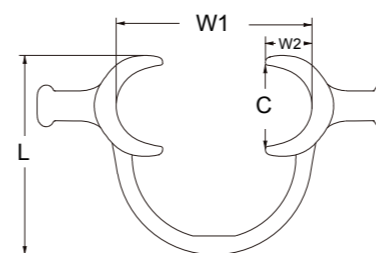
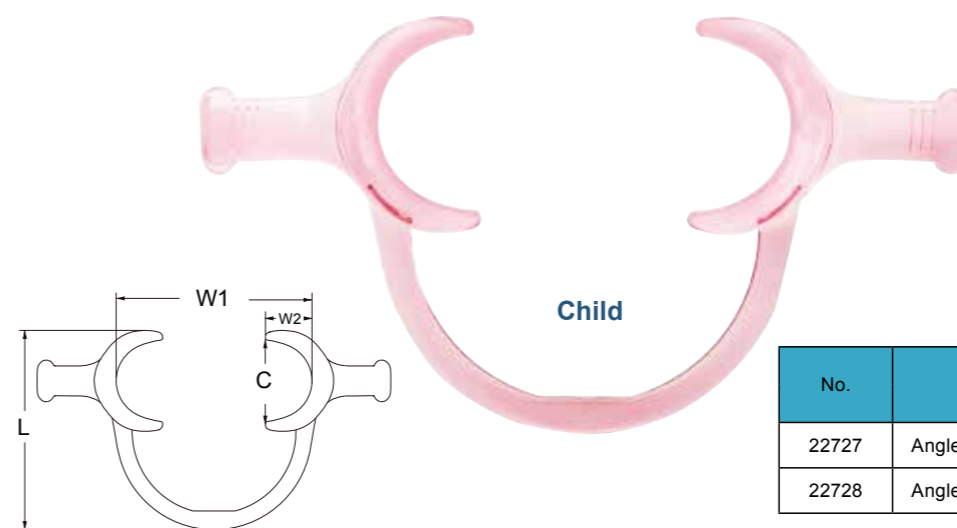

\*Material / TPX

No.	Description	Size (mm)			
		W1	W2	L	C
22727	Anglewider Wide(2 ea.)	96	23	100	40
22728	Anglewider for Child (2 ea.)	67	16	68	40



# Cheek Retractor

**-Doublewider-** \*Retract cheeks, lips, and tongue for maximum visibility and patient's comfort.  
 \*Suitable for dental aesthetic instruction, inoffice bleaching and bracket wearing in orthodontic treatment.

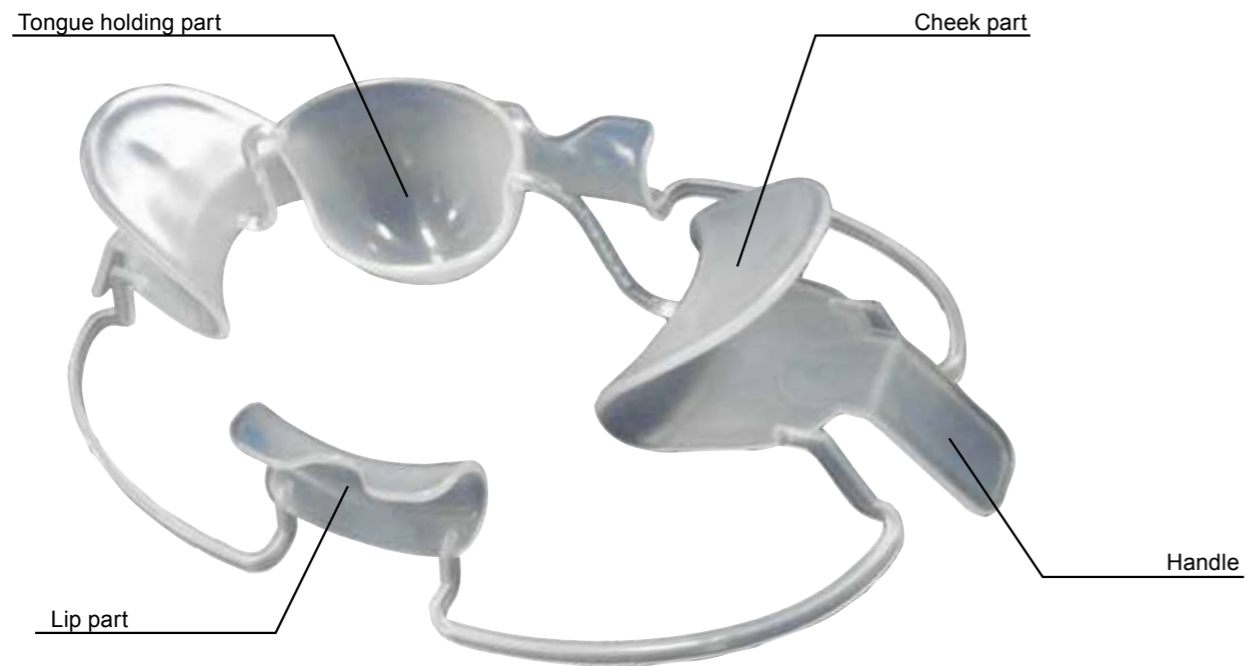

\*Material / PP : Deflection temperature 120°C

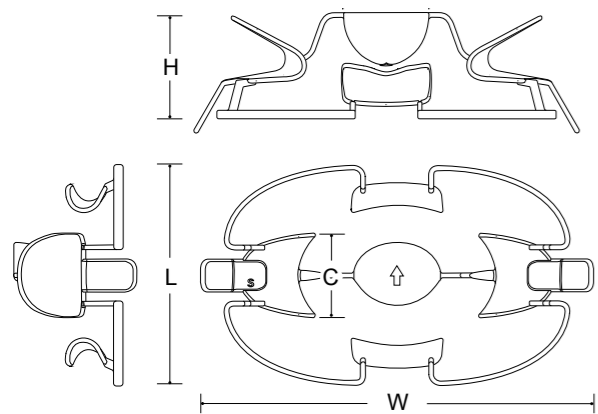

No.	Description	Size (mm)			
		W	L	H	C
22750	Doublewider L (2 ea.)	171	96	54.5	38
22749	Doublewider S (2 ea.)	161	90	50.5	35
22725	Doublewider SS (2 ea.)	157	80	42	25



\*Tongue holding part can be removed if you don't need it.

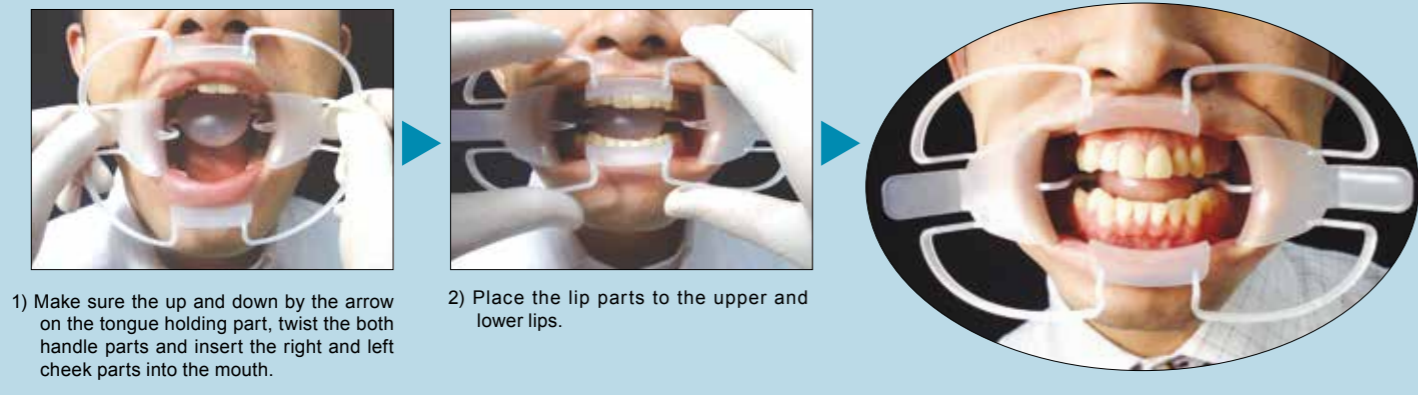

# Photographic Mirror Crystal



**-Made of Japanese glass-**

- \*Dielectric multilayer coating
- \*Reflection rate / About 98%
- \*Light weight
- \*One sided

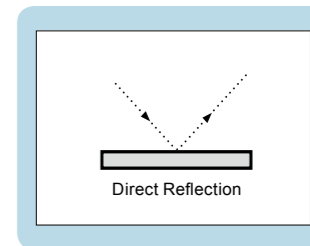

**Occlusal L**  
No. 13282



**Occlusal M**  
No. 13283



**Buccal & Lingual**  
No. 13281

\*Thickness / 3.0mm

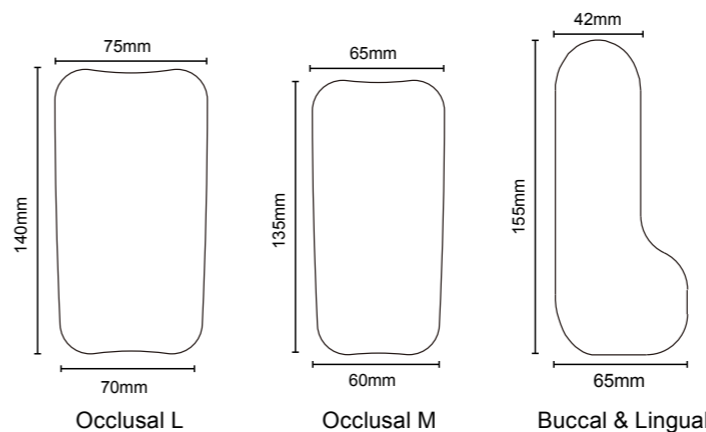

Photographic Mirror

**-Stainless Steel-**

- \*Use of stainless steel avoids breakage, allowing long term use of the mirror.
- \*Sterilization pouch included.
- \*In sterilization, put mirror into pouch without disposal sterilization pack.

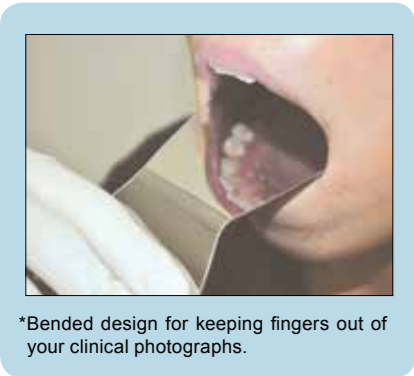

\*Bended design for keeping fingers out of your clinical photographs.

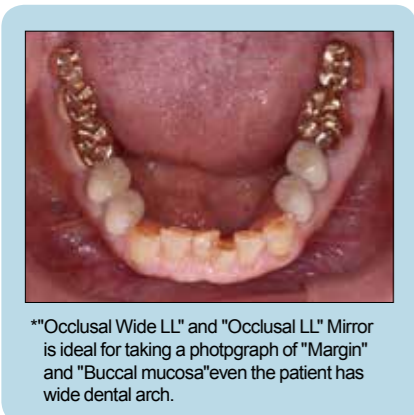

\*\*"Occlusal Wide LL" and "Occlusal LL" Mirror is ideal for taking a photograph of "Margin" and "Buccal mucosa" even the patient has wide dental arch.

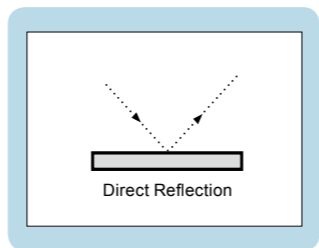

\*Rhodium Coating  
(With "Rhodium" marking on the back side)  
\*Reflection rate / About 85%

No.	Description
13578	Occlusal Wide LL
13576	Occlusal Wide L
13577	Occlusal Wide S
13571	Occlusal
13572	Lingual
13573	Buccal

**-ST-**  
\*Without Rhodium Coating  
\*Economy Type  
\*Reflection rate / About 65%

No.	Description
13266	ST Occlusal Wide LL
13264	ST Occlusal Wide L
13265	ST Occlusal Wide S
13261	ST Occlusal
13262	ST Lingual
13263	ST Buccal

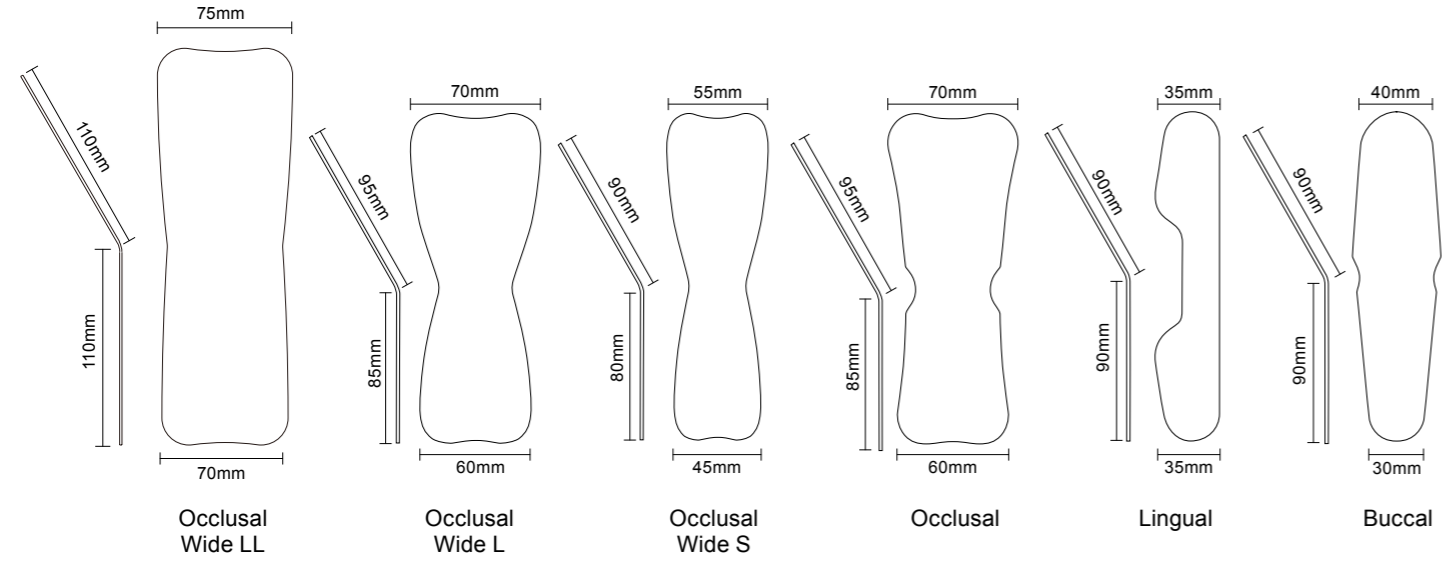

**Made of "Hard Stainless steel"**

\*YDM Photographic Mirrors have more hardness than normal stainless steel. This feature makes YDM photographic mirrors hardly scratched and distorted.

\*It can be damaged under improper use.

**Hardness Comparison(Vickers Hardness)**

[YDM Photographic Mirror] Hard Stainless steel + Rhodium coating	approx. 533HV
[YDM Photographic Mirror ST] Hard Stainless steel	approx. 369HV
[Normal Rhodium coated mirror] Normal Stainless steel + Rhodium coating	approx. 240HV
[Normal Rhodium coated mirror] Normal Stainless steel	approx. 198HV

**-SE-**

\*Without Rhodium Coating  
\*Economy Type  
\*Reflection rate / About 65%



Occlusal LL No. 13274      Occlusal L No. 13272      Occlusal M No. 13273      Buccal & Lingual No. 13271

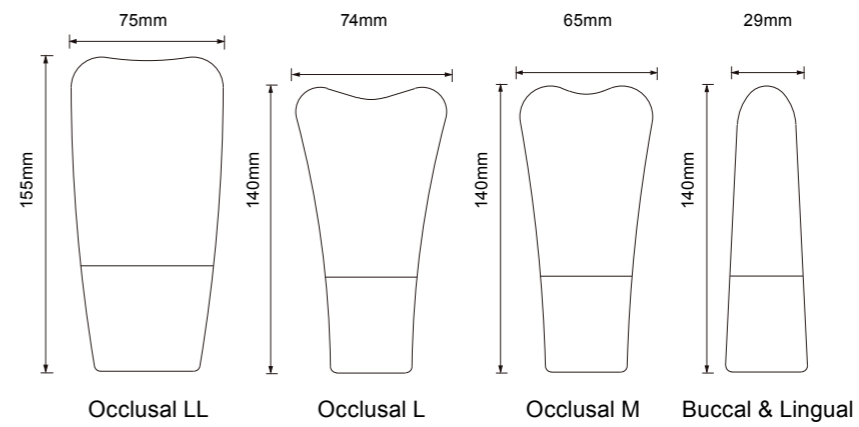



## Contraster

**\*Teflon coated aluminum.**

- \*Suitable for checking shade breaching and examining of wedge shaped defects and cervical caries, etc.
- \*Designed to fit the shape of dental arch.



**Anterior L**  
No.13641



**Anterior S**  
No.13643



**Posterior**  
No.13642



	With contraster	Without contraster
Upper Anterior		
Lower Posterior		

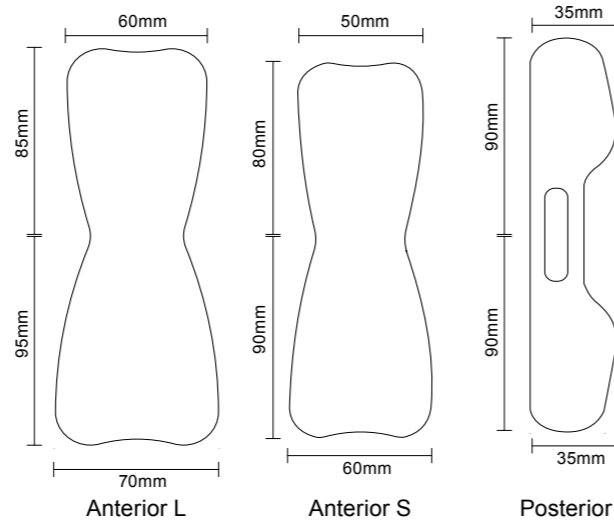

## Bur Guard

- \*Color-coded design allows organization of burs according to their type, treatment method, length, etc.
- \*The cover will not allow burs to fall out.
- \*Also used for storage for engine reamers.

No.	Description
13471	Yellow
13472	Orange
13473	Pink
13474	Blue
13475	Green



- \*Storage Capacity / 12 burs.
- \*Holding length / from 17 to 37mm (When using the long cover / from 32 to 52 mm)
- \*Size / W69 x D10 x H41.5 to 56.5mm (When using long cover / W69 x D10 x H55 to 70mm)
- \*Material / POM
- \*Sterilizable with liquid sterilizing solutions.
- \*Product does not include burs.

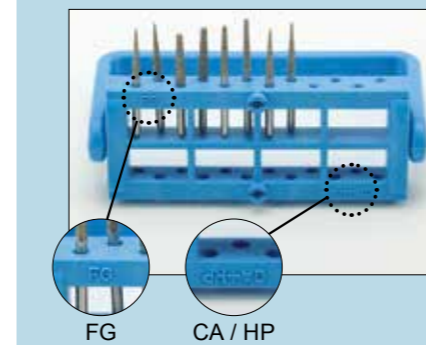

FG CA / HP

\*The main body is reversible for use in either FG burs or CA / HP burs.



\*The height can be adjusted to three levels.

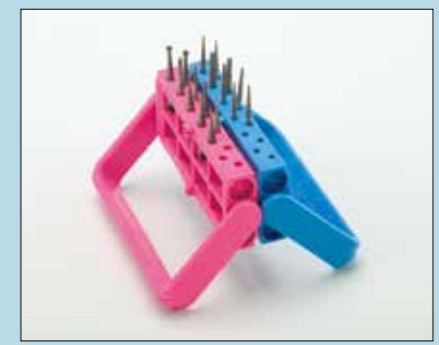

\*Each "Bur Guard" can be connected.

### Sold Separately

#### Long Cover



No.	Description
13481	Yellow
13482	Orange
13483	Pink
13484	Blue
13485	Green



Long Cover Regular

\*Also able to hold laboratory hand piece burs when using the long cover.

#### Case No. 08439



- \*Storage Capacity / 18 ea.
- \*Size / W167 x D126 x H62mm
- \*Sterilizable with liquid sterilizing solutions.
- \*Product does not include "Bur Guard".



## Bur Stand

### -Safety 2-

- \*Lid will not allow the burs to fall out.
- \*Able to apply ultrasonic cleaning, liquid sterilizing solutions, and autoclavable while the burs stand inside the block.

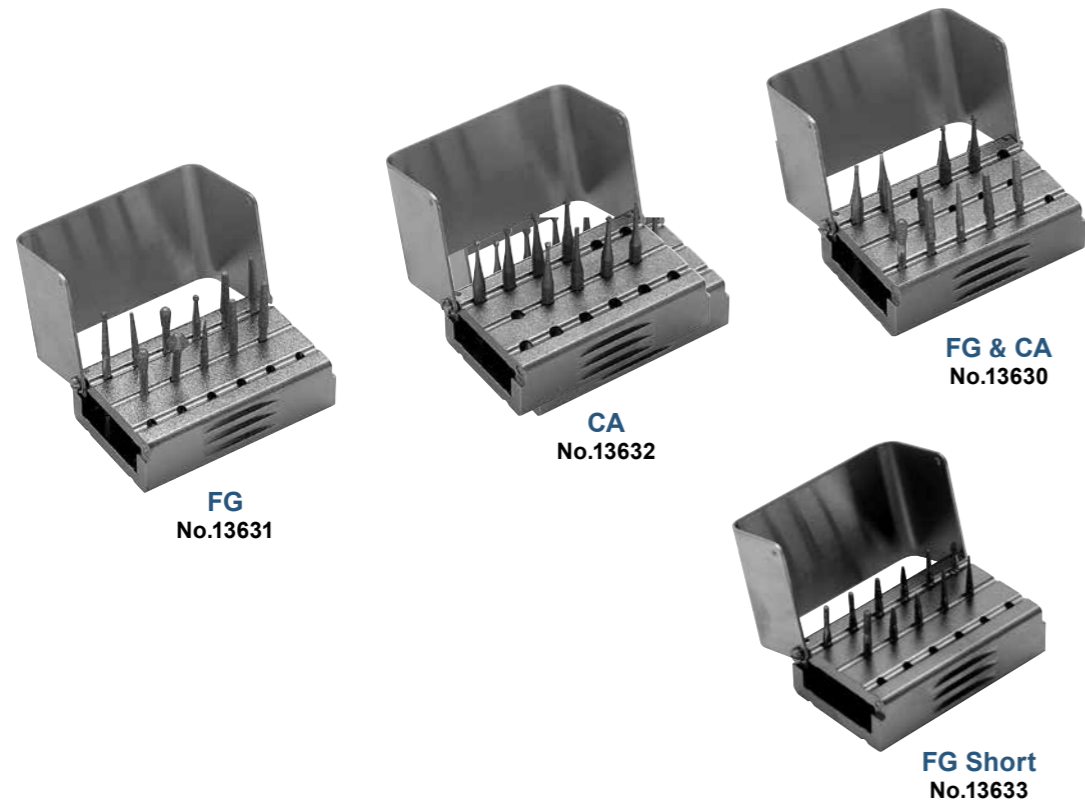

- \*Storage capacity / 17 burs (FG & CA : FG / 11 ea., CA / 6 ea.)
- \*Holding length / from 21 to 25mm (FG, CA, FG & CA)  
from 17 to 21mm (FG Short)
- \*Size / W40 x D25 x H29mm (FG, CA, FG & CA)  
W40 x D25 x H25mm (FG Short)
- \*Product does not include burs.

### -ST Set-

**Contents** Stand for CA Green, FG Pink / Cover

No.13406

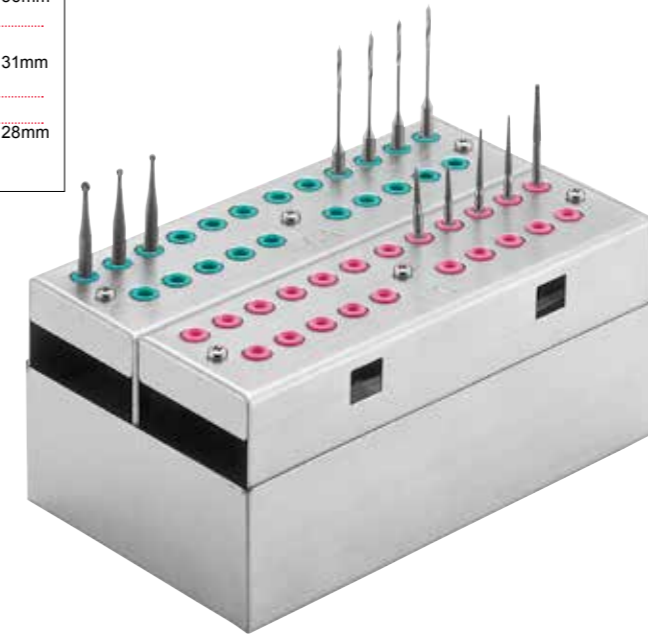
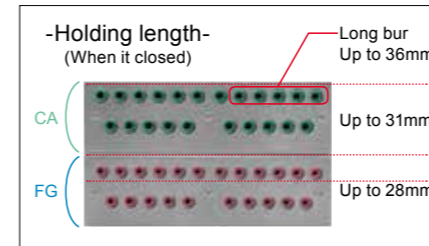

- \*Storage capacity / 44 burs (CA / 22 ea. (5 ea. for long bur), FG / 22 ea.)
- \*Size / W94 x D56 x H40mm
- \*Material / PP (Green part, Pink part)
- \*Product does not include burs.

\*Lid can be attached bottom of the stand and unified.

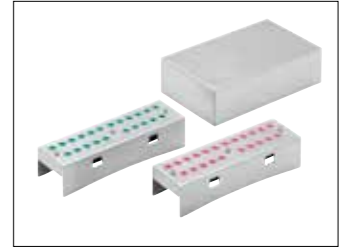

### Individual Parts

No.	Description
13407	Stand for CA Green
13408	Stand for FG Pink

## Bur Stand



### -Block System Set-

**Contents** Block for CA (3 ea.), HP (2 ea.), FG (2 ea.) / Case

No.13440



### Individual Parts

No.	Description
13441	Block for CA Light Blue
13442	Block for HP Blue
13443	Block for FG Ivory
13444	Case



- \*Storage capacity (In each block) / 12 burs
- \*Holding length (When it closed) / up to 29mm (CA)  
up to 51mm (HP)  
up to 25mm (FG)
- \*Size / W100 x D70 x H50mm (Case)  
W83 x D8 x H38mm (Block)

### -Magnetic-

No.13301



- \*Size / W82 x D25 x H28mm
- \*Some burs will not be hold by magnet.
- \*Product does not include burs.

### -Cube Type-2-

No.13400

\*Lid can be attached bottom of the stand and unified.



- \*Storage capacity / 108 burs (HP / 54 ea., CA / 54 ea.)
- \*Holding length (When it closed) / up to 48mm (HP)  
up to 27mm (CA)
- \*Size / W100 x D69 x H49mm



## One-Touch Cotton Box

2 Wells  
No.13555



\*Lid at the bottom is useful for replenishing of cottons.



\*The frame allows you to take out cotton one by one.

3 Wells  
No.13557



\*Size / W102 x D56 x H 61.5mm (2 well)  
W153.5 x D56 x H61.5mm (3 well)  
\*Product does not include cotton.

### -Pellets-

No.13559



\*The whole box of swab is set from the bottom.

\*Size / W46 x D46 x H52mm  
\*Product does not include pellets.



## One-Touch Cotton Box Type-2

-for Alcohol-

S  
No.13621

L  
No.13622



Size / ø80 x H57mm (S)  
ø103 x H82mm (L)

## Cotton Dispenser



No. 13623

Pellets  
No. 13624

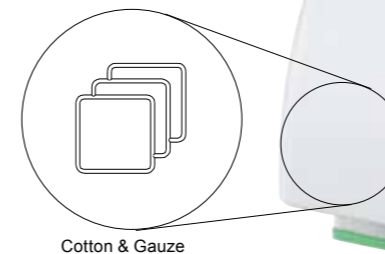

Cotton & Gauze

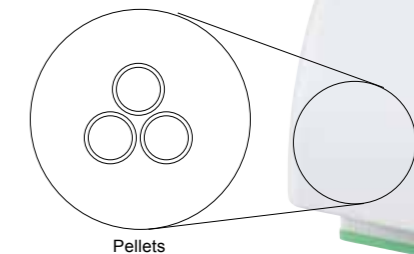

Pellets

\*Size / W61 x D61.5 x H81.5mm  
\*Inside diameter / 50 x 50mm  
\*Slot / 31 x 30mm  
\*Mesh / 7.5 x 7.5mm (Only Pellets)  
\*Material / SPS (Main body)  
Si (Bottom Silicon Lid / O-Ring)



\*Smooth opening and closing slide lid.



\*If cottons decrease, push up the bottom and maintain the position to take out easily.



\*Since it supplies from a bottom, it can supply without taking out the remaining cotton.







## Phial Stand One-Touch

\*Easy opening of lid by just flipping up the cover.

No.13520



\*Size / W100 x D52 x H55mm  
\*Material / Si (Stand base)  
\*Dimension for medicine bottle space.  
\*Product does not include medicine bottle.

## Z-1 eco Fine Liquid

No.13538



High detergency  
\*Alkaline ph works exelently well against protein and fat content.  
This liquid is efficient for any metal materials due to the special blended component.

Stable detergency  
\*Z1 doesn't matter the temperature of dilution water.(enzyme is not included)

Protect surface  
\* Colloidal particle wraps removed dirt and prevent reattachment.

Rust prevention  
\* Z1 has excellent rust prevention power thanks to its sequestering agent.

Good cost performance and compact bottle  
\*200 fold dilution.  
Purified water is recommended in dillution.  
\*Easy to meaura by one hand.

Less damage on environment  
\*Z1 is refined from rosin oil , plant based detergent.,  
\*Biodegradation rate is as high as 97.5% ,Z1 can be drained after cleaning

[Form and Component]  
■Form : 500ml concentrate(will be 100L by 200 fold dilution)  
■Component : Alkaline surfactant as plant based detergent with rust prevention material  
\*Anionic surfactant,Nonionic surfactant  
\*norganic builder(silicate, carbonate)  
\*Organic builder(carboxylic acid etc..)

\*Please follow and confirm the relevant laws or regulations of your country for import.





## Sterilization Cassette

### -Type-A-

**Contents** Main body / Single End Clip (3 ea.)

\*Stackable cassette.

\*Clips are used for holding / fixing single-end instrument.

No.24004



\*Storage capacity / 8 ea.  
\*Size / W185 x D120 x H25mm  
\*Material / PPS

### -Type-B-

**Contents** Main body / Single End Clip (3 ea.)

\*Stackable cassette.

\*Clips are used for holding / fixing single-end instrument.

No.24009



#### Sold Separately

No.	Description
13531	Yellow (10 ea.)
13532	Red (10 ea.)
13533	Blue (10 ea.)
13534	Green (10 ea.)
13535	Pink (10 ea.)
13682	Black (10 ea.)
13684	White (10 ea.)
13688	Violet (10 ea.)

\*Storage capacity / 5 ea.  
\*Size / W185 x D80 x H25mm  
\*Material / PPS

### Example of cleaning and sterilization flow

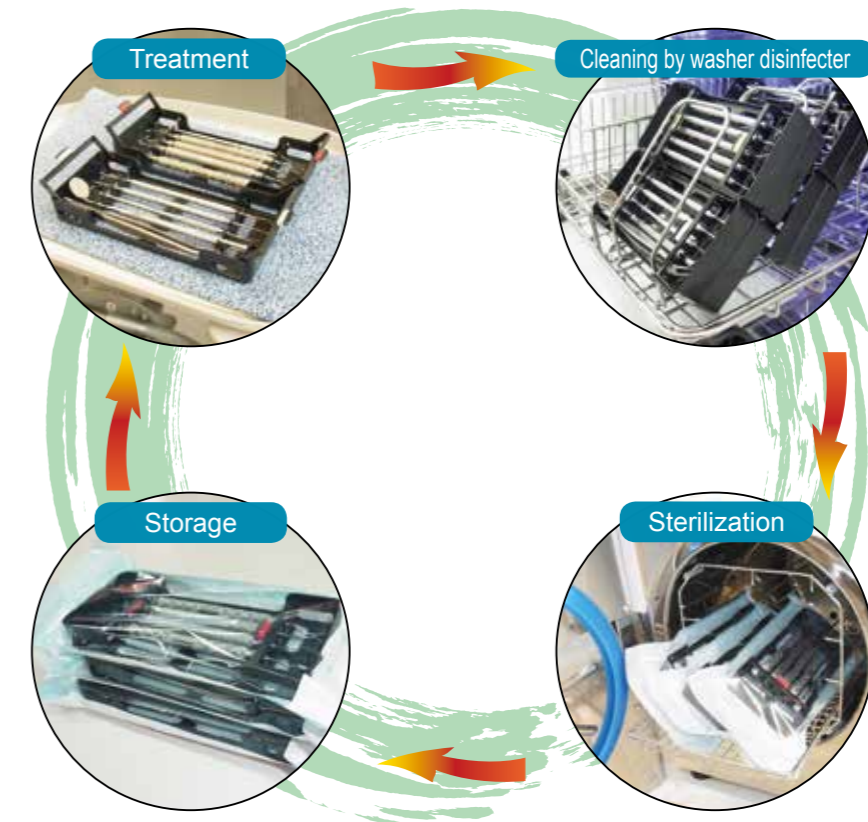

### Clips for short instrument

Clips are used for holding / fixing single-end instrument

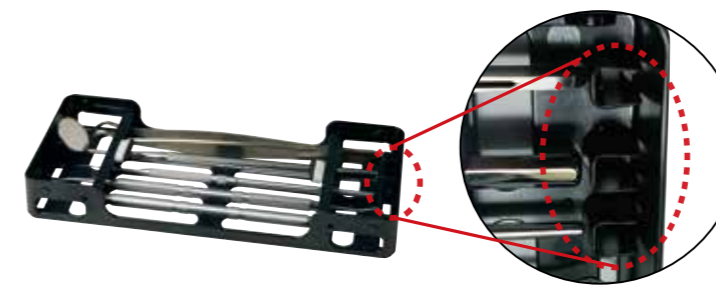

#### Individual Parts



**Single End Clip**  
**No.90340**  
**(3 ea.)**

### Can be stored in piles

This cassette is able to be piled to save the space





## Sterilization Case



**MS #1**  
**No.24021**

Inside diameter / W267 x D159 x H16mm  
Outside diameter / W285 x D175 x H33mm



**MS #2**  
**No.24022**

Inside diameter / W267 x D159 x H35mm  
Outside diameter / W285 x D175 x H52mm

\*Material / PES (Main body)  
Si (Mat)

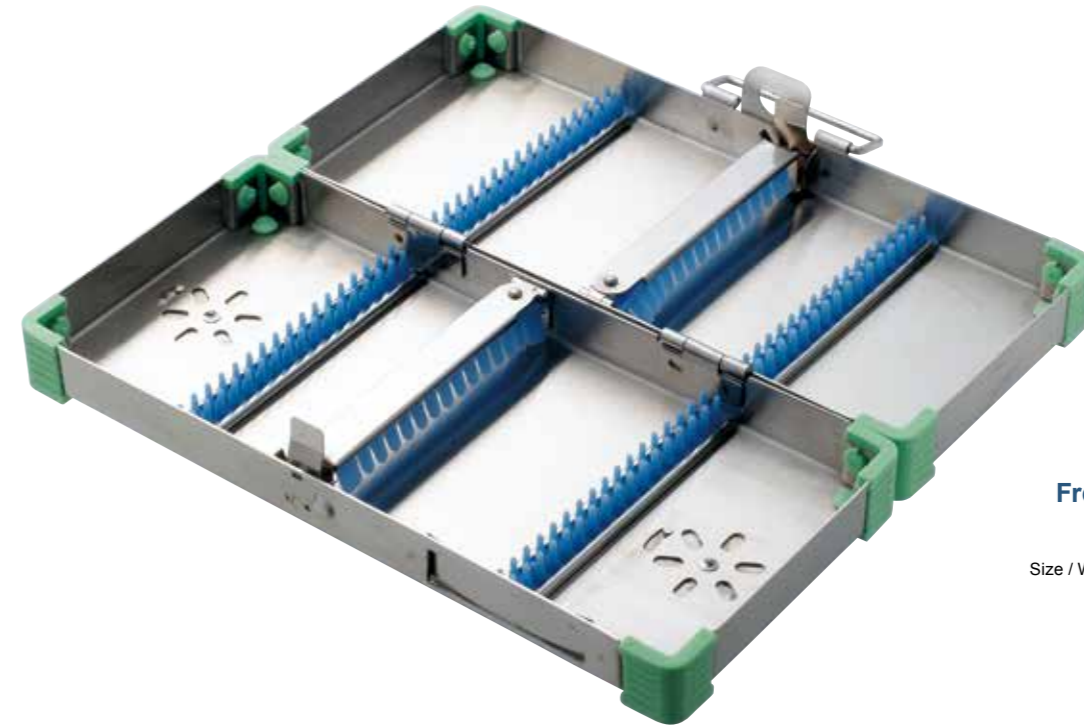

**Free M Green**  
**No.24043**

Size / W202 x D92 x H40mm

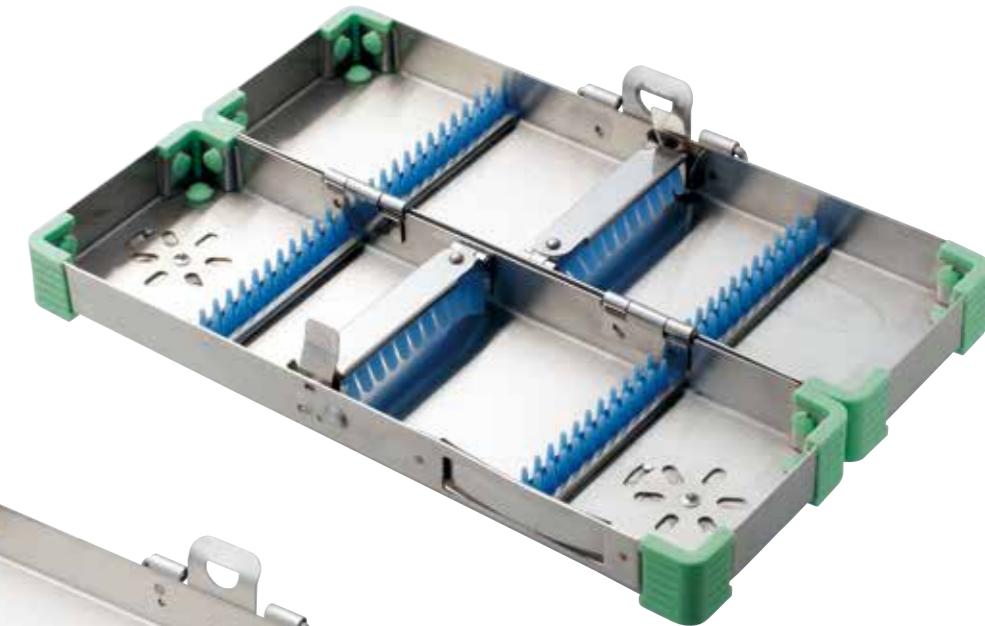

**Free S Green**  
**No.24042**

Size / W202 x D65 x H40mm

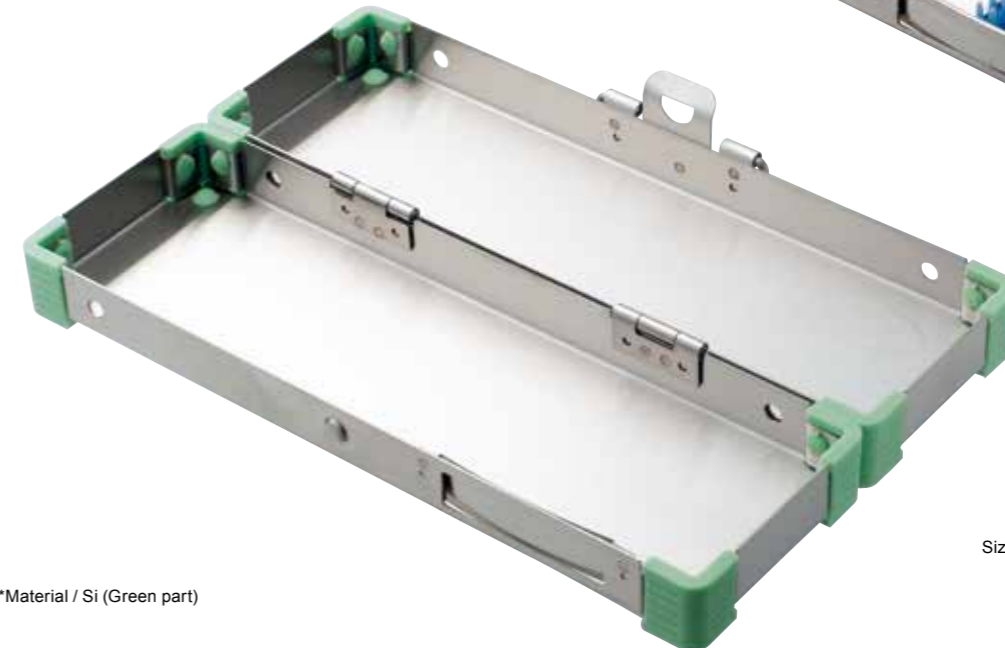

**S Green**  
**No.24041**

Size / W202 x D 65 x H40mm

\*Material / Si (Green part)





## Bur Pot Set



**Contents** Pot / Basket (2 ea.)

No.13304

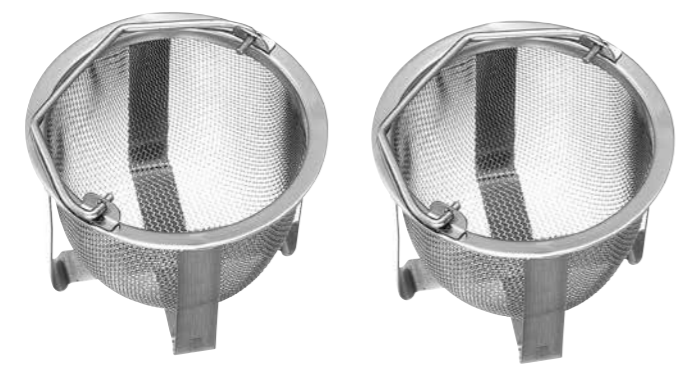

\*Size / ø75 x H55mm (Pot)  
ø70 x H45mm (Basket)



## Bur Basket

No.13445

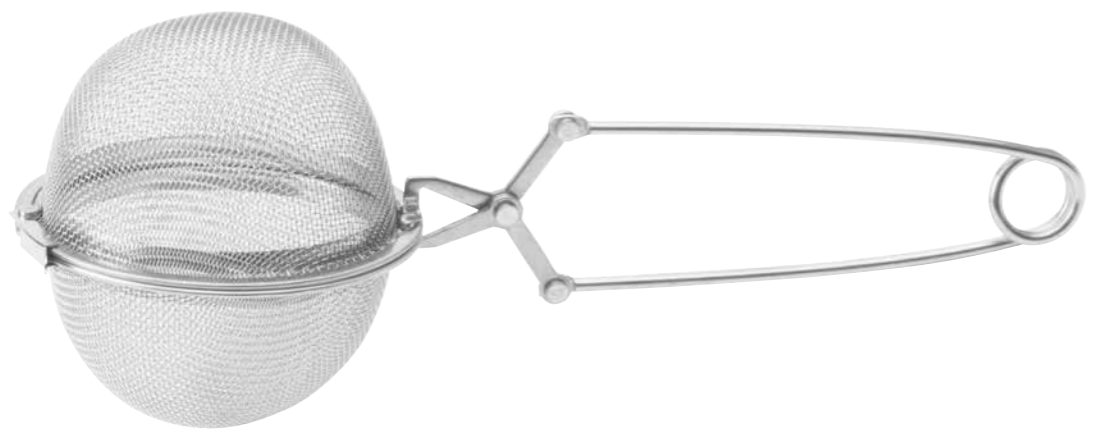

\*Size / ø60 x H66mm

## Grooved Forceps



\*Convenient for carrying of the instrument after sterilization.

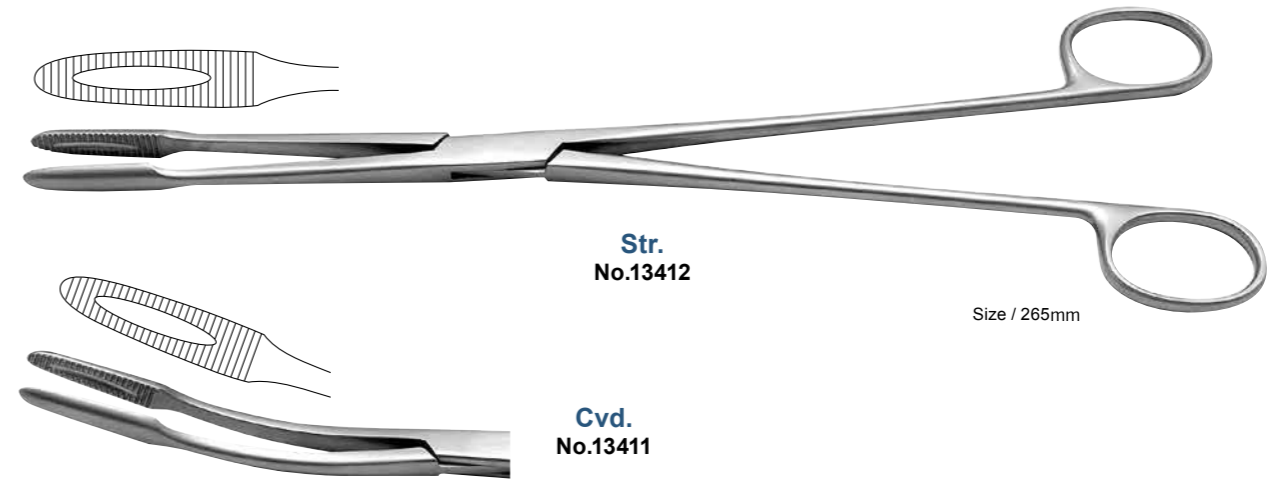

Str.  
No.13412

Size / 265mm

Cvd.  
No.13411

Size / 260mm

## General Tweezers



Size / 230mm

23cm  
No.13414

## Instruments Stand



No.13547



\*Size / Inside diameter ø90 x H135mm  
\*Product does not include instruments.





## Color Tape

\*Tape is protected by plastic case with open and close lid for sanitary purpose.

No.	Description
13661	Red
13662	Yellow
13663	Blue
13664	Green
13665	White
13666	Black



\*1 roll / about 3m  
 \*Width / 3mm  
 \*Size / W8 x D72 x H44mm  
 \*Material / Polyester : Deflection temperature 125°C



## Sterilization Cap

\*Protect cutting edge during sterilization, disinfection and storage.  
 \*There are two kinds of size.



**S**  
**No.13542**  
 (20 ea.)  
 Inside diameter / ø2mm  
 Size / 20mm

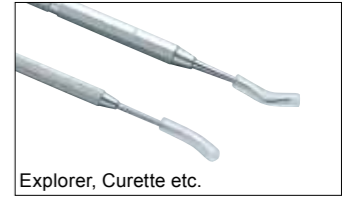

## Cleaning Brush

\*Material / Si

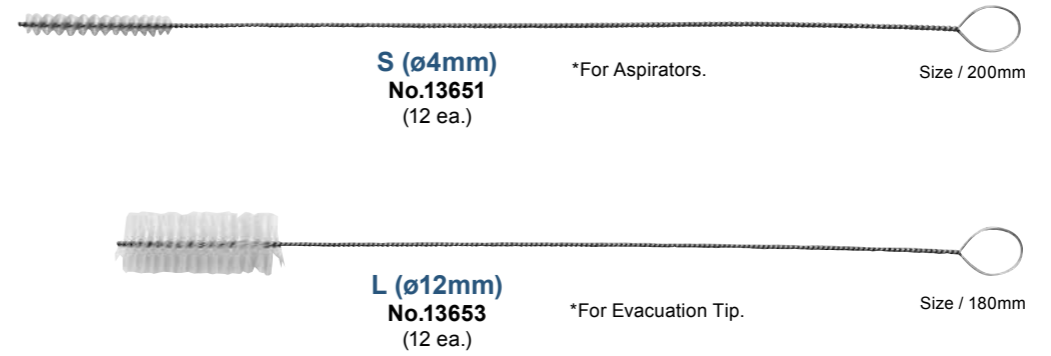

## Color Ring



\*Material / Si

**-S-** Outside diameter / ø6mm  
 Inside diameter / ø4mm,  
 Size / 3mm



\*Explorer, Orthodontic Pliers etc.

No.	Description
13523	Red (20 ea.)
13524	Green (20 ea.)
13526	Blue (20 ea.)
13527	Black (20 ea.)
13528	Yellow (20 ea.)
13530	White (20 ea.)
13671	Pink (20 ea.)
13675	Violet (20 ea.)

**-L-** Outside diameter / ø10mm  
 Inside diameter / ø8mm  
 Size / 5mm

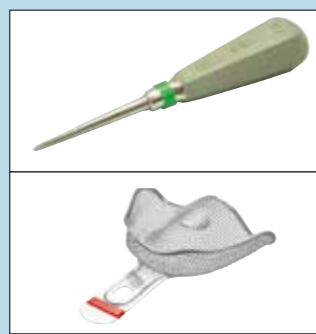

\*Round Handle Sakura, Impression Tray, Elevator etc.

No.	Description
13532	Red (10 ea.)
13534	Green (10 ea.)
13533	Blue (10 ea.)
13682	Black (10 ea.)
13531	Yellow (10 ea.)
13684	White (10 ea.)
13535	Pink (10 ea.)
13688	Violet (10 ea.)

## Cleaning Wire

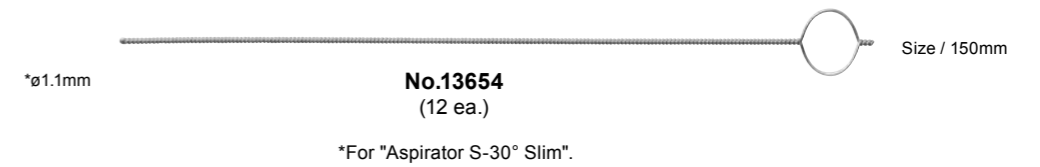



## Instrument Oil

- \*For rust prevention and sharpening.
- \*Please put a little of this oil before autoclave for rust prevention.
- \*This oil works excellent for the joint part of pliers and forceps as well.
- \*This oil also can be used for sharpening scaler and curette.
- \*Please follow and confirm the relevant laws or regulations of your country for import.

**No.13093**



## Utility Scissors



- \*This is the product, which YDM and "PLUS Corporation", known as stationery, produced together. Its cutting edge adopts Bernoulli's curve.
- \*Bernoulli's curve allows you to cut soft and hard things; it supports a wide range of hardness.
- \*It's especially cut out for cutting sterilized cotton, gauze, occlusal registration papers, sheets for mouth guards.

\*The range that the scissors copes with  
 Soft sheets : 4.0mm  
 Hard Sheets : 1.0mm

**No.12002**

