



Parts

Diagnosis 232

Temporary Filling Carrier

Periodontics 232

Periodontal Curette / Sharpener

Conservative Treatment 232

Composite Syringe / Rubber Dam Punch / Clamp Forceps /
Rubber Dam Kit / Reamer Stand / Endodontic Aspirator /
Irrigation Syringe / Fiber Cutter

Surgery 234

Mallet / Mouth Gag / Injection Cartridge Syringe /
Jaw Opening Trainer

Implantology 235

Bone Mill / Parallel Meter

Prosthetics 236

Crown Removing Pliers / Agar Syringe / Contact Gauge /
Crown Splitting Pliers

Laboratory Techniques 237

Konus Crown Pliers / Spacy Articulator / Face Bow /
Accessories for Spacy Articulator / Unity Articulator /
Partial Articulator / Flask / Laboratory Calipers /
Dental Caliper / Parallel Meter / Handy Torch

Orthodontics 242

Handy Torch / Orthodontic Pliers EVER /
Convertible Cap Removing Pliers / Tying Pliers / Separator /
Band Seater /

Other Chair-side Products 244

Almighty Mouth Gag / Photographic Mirror /
One-Touch Cotton Box / Cotton Dispenser /
Phial Stand One-Touch / Sterilization Cassette /
Sterilization Case / Bur Pot



Temporary Filling Carrier

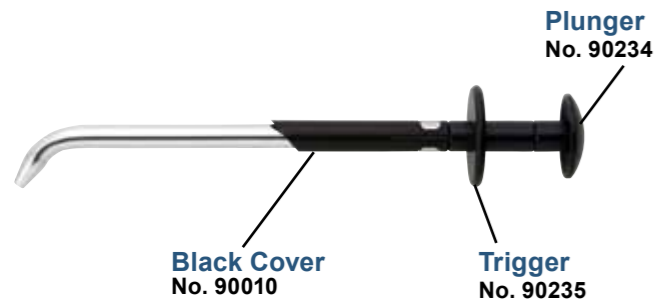

Periodontal Curette

-KK-Type-

Contents Color Ring S Red, Pink, Yellow, White

No. 90399

-S-

Outside diameter / ø6mm
Inside diameter / ø4mm,
Ring width / 3mm



Rubber Dam Kit Type-2

Corner Green
No. 90389
(2 ea.)

Silicon Stopper
No. 90259

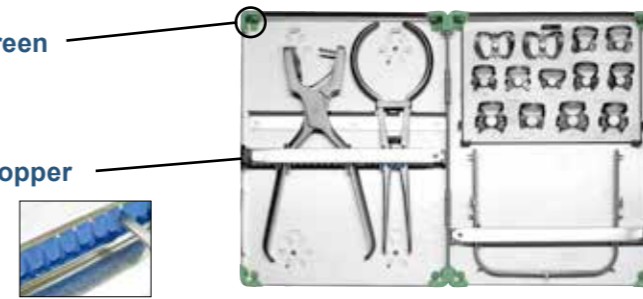

Sharpener Re Born

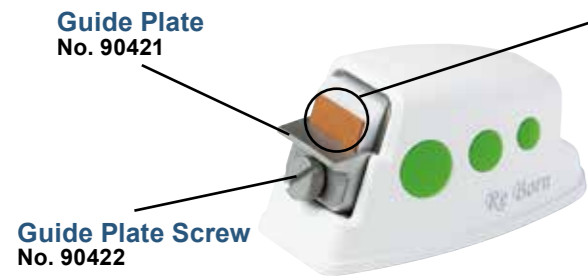

Reamer Stand

-Safety-



Endodontic Aspirator Type-2

-Str. / Cvd.-

Cleaning Wire
No. 90341



Composite Syringe Type-2

-L / S-

Adaptor
L : No. 90370 *Adaptor L and S have the compatibility.
S : No. 90371

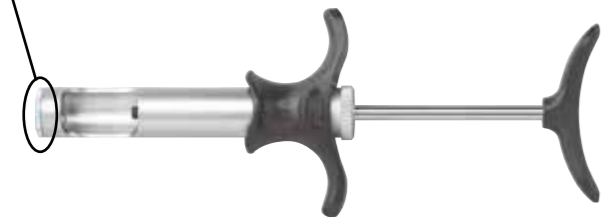

Rubber Dam Punch Type-2

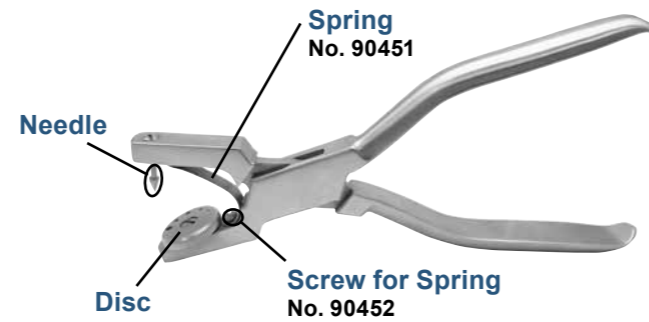

*Needle & Disk are need to be repaired at YDM Corp.

Irrigation Syringe

Head O-Ring
No. 90335
(10 ea.)

Syringe O-Ring
No. 90332
(10 ea.)

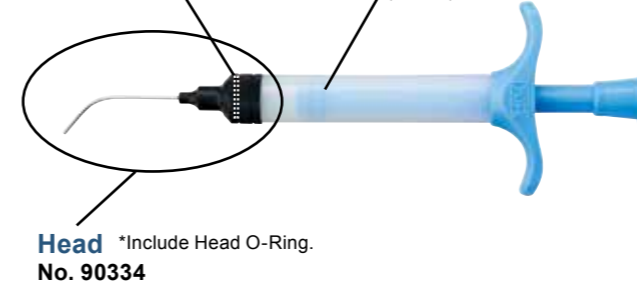

Fiber Cutter Type2



Clamp Forceps

-YS-

Spring
No. 90014

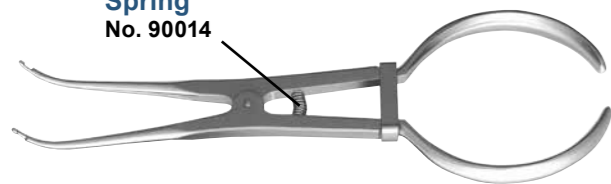

-Brewer-

Spring
No. 90217

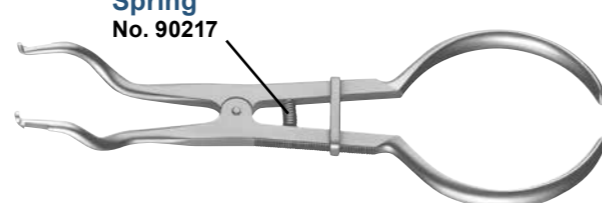



Mallet

-Universal-



Base
No. 90306

-Soft-



Base
No. 90035

-Hard-



Cap
No. 90036

Base
No. 90385

Jaw Opening Trainer

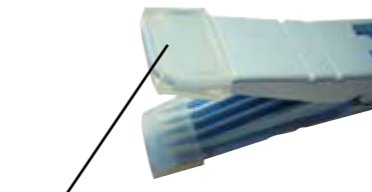

Silicon Cover
No. 90424
(2 ea.)

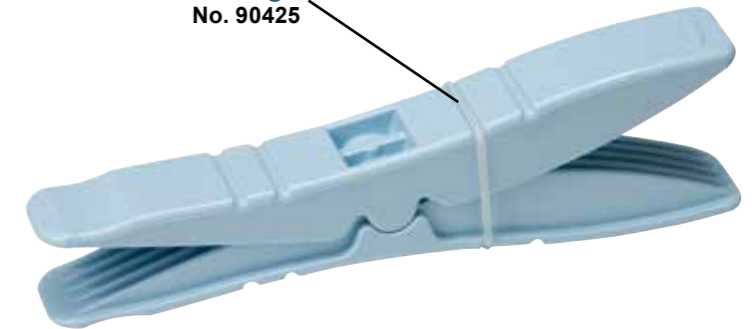

O-Ring
No. 90425

Mouth Gag

-Heister-

Silicon Cover
No. 90393
(2 ea.)

*Inside diameter / ø8mm
*Size / 35mm



-Roser-Koenig-

Silicon Cover
No. 90394
(2 ea.)

*Inside diameter / ø7mm
*Size / 35mm



Injection Cartridge Syringe Type-2

-A / B-



Screw Cap
No. 90209

Lure Lock Cap
No. 90320

*Screw Cap and Lure Lock Cap have the compatibility.

Bone Mill

-ex-2-



Sterilization Container
No. 90401

Lid in Container
No. 90411
(5 ea.)



Grinding Drum
Cleaning Comb
No. 90400

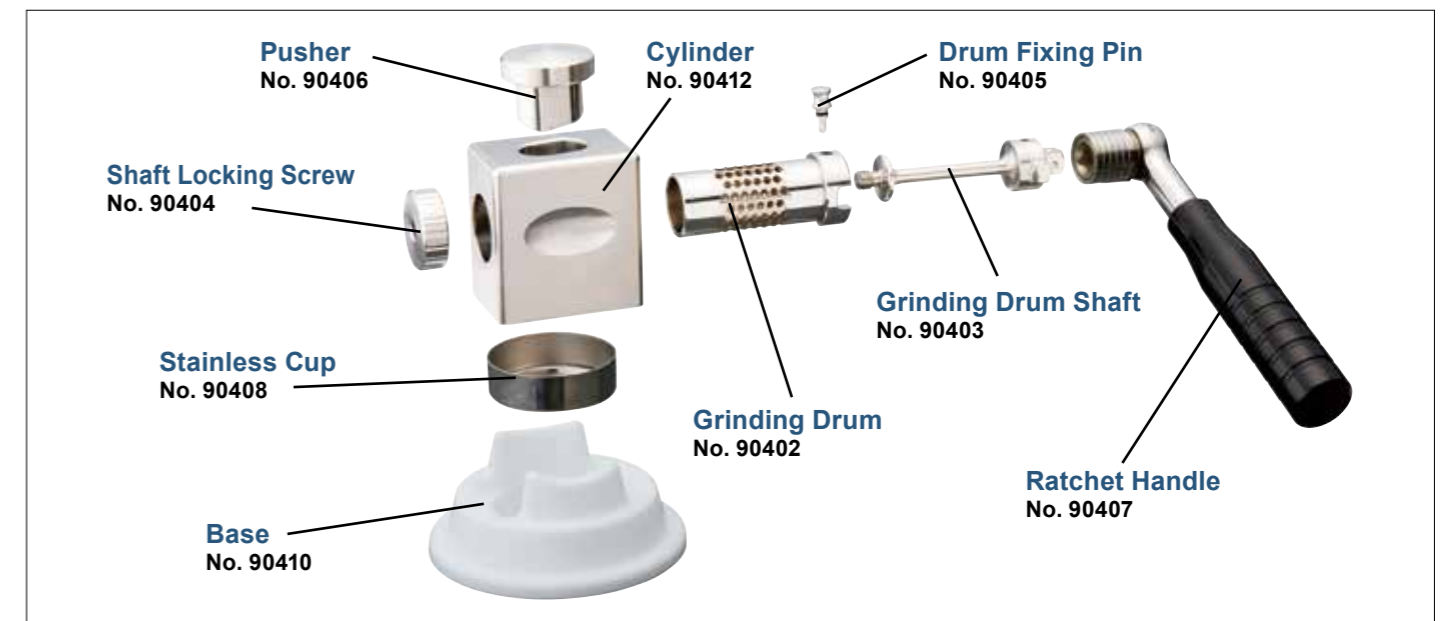

Pusher
No. 90406

Cylinder
No. 90412

Drum Fixing Pin
No. 90405

Shaft Locking Screw
No. 90404

Grinding Drum Shaft
No. 90403

Stainless Cup
No. 90408

Grinding Drum
No. 90402

Base
No. 90410

Ratchet Handle
No. 90407





Parallel Meter

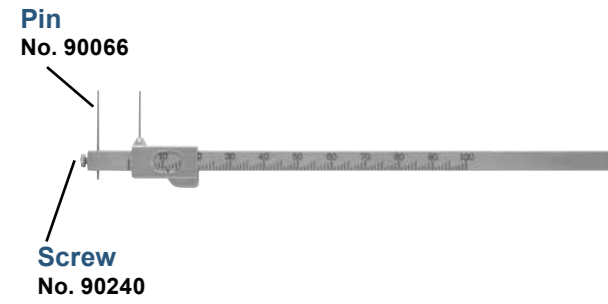

Crown Removing Pliers Professional



Crown Removing Pliers Professional for U.A



Agar Syringe

-(5/16) Type-2-

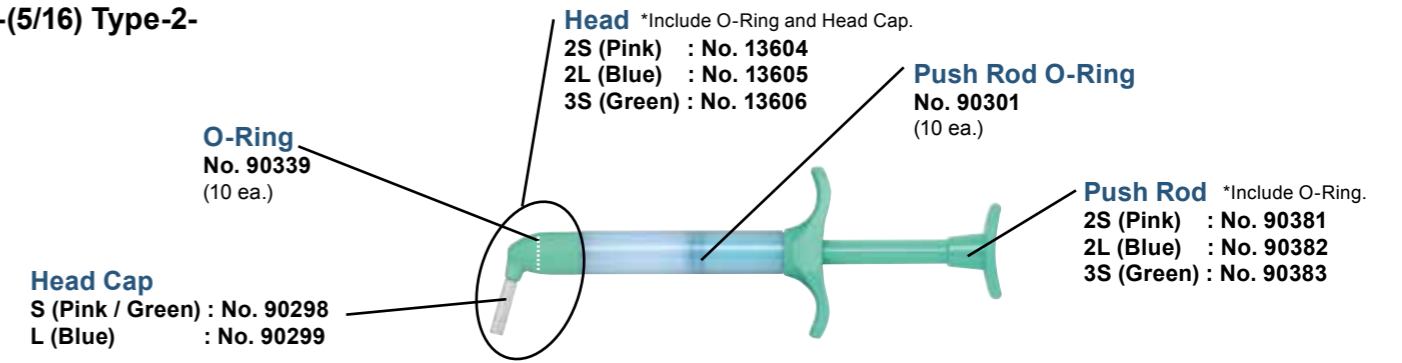

-(CT) Set-

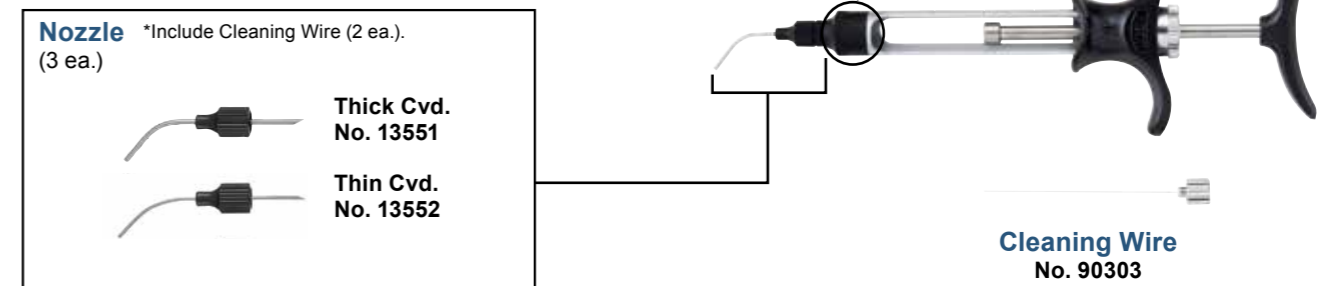

Contact Gauge

-Double End Holder Set / Single End Holder Set-



Crown Splitting Pliers

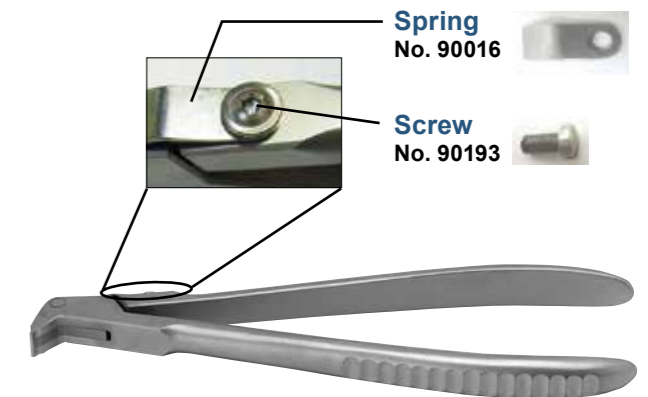

Konus Crown Pliers

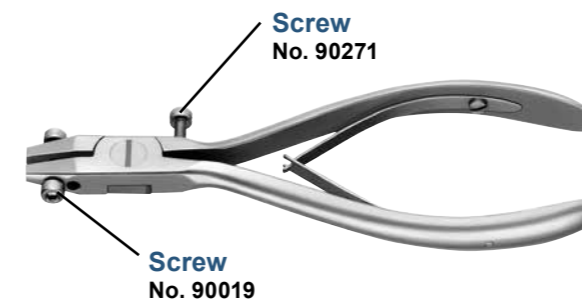



Spacy Articulator (Average Type)

Arcon

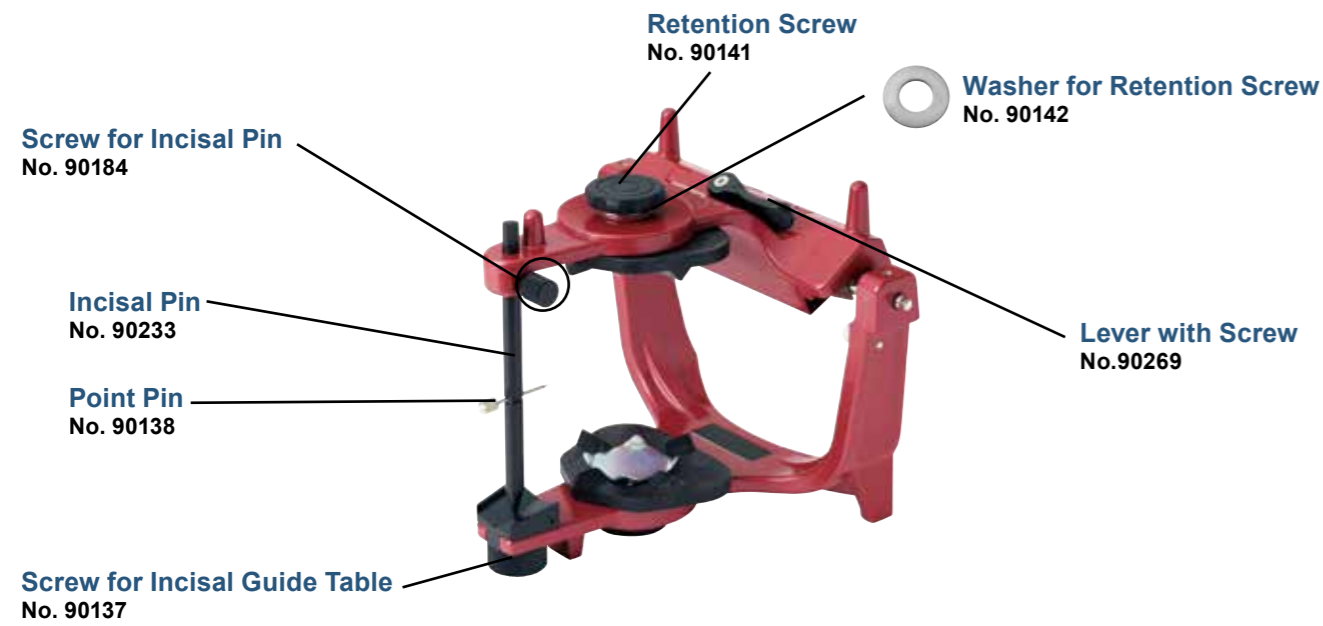

Spacy Articulator (Semi-Adjustable)

Mobile

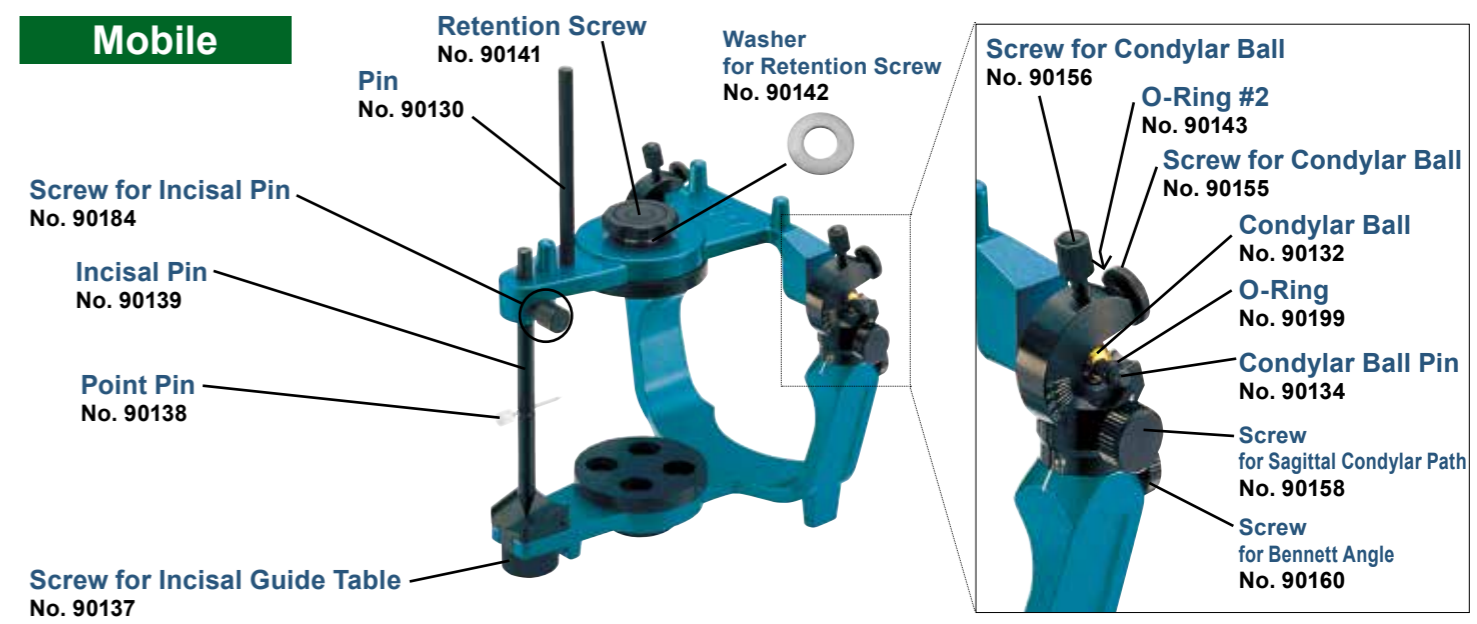

Smart 2

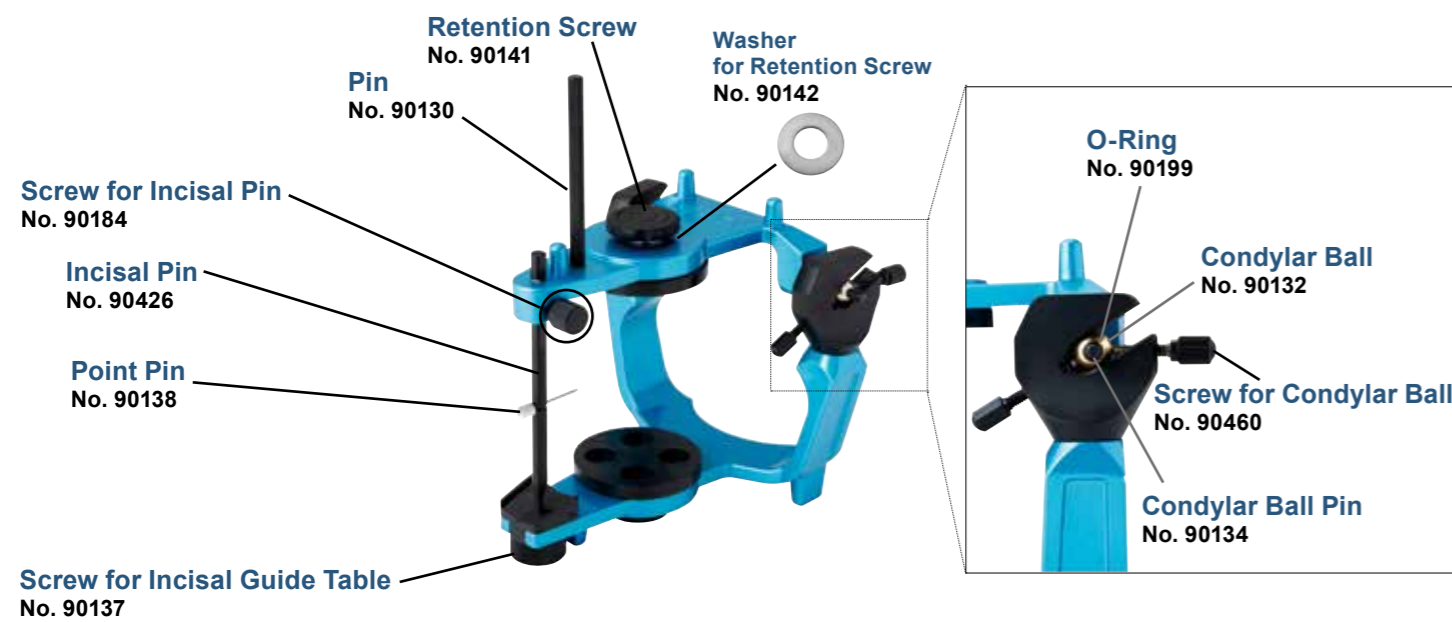

Wing

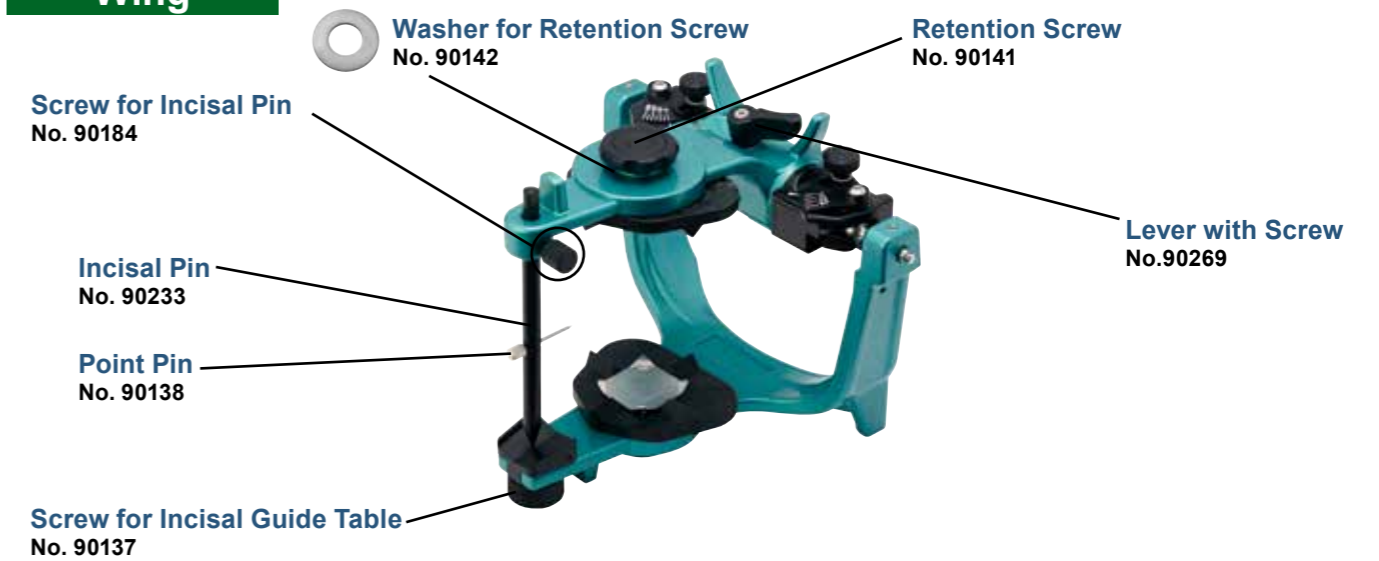



Face Bow Type-2

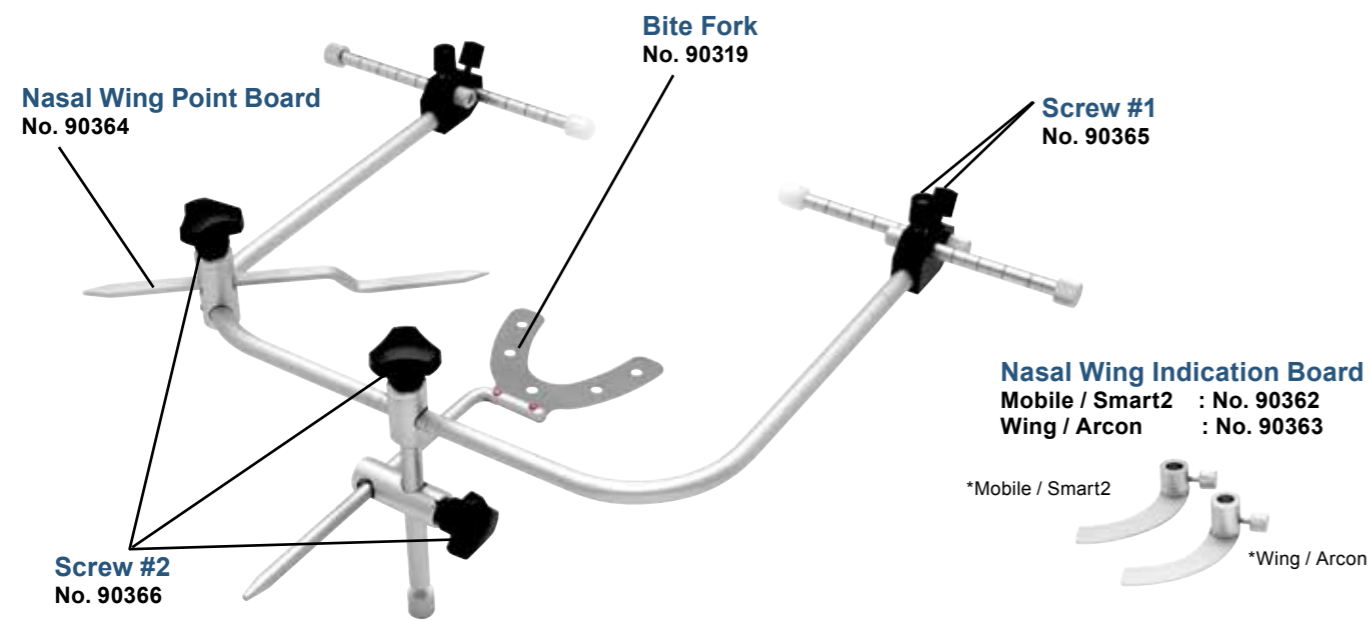

Partial Articulator

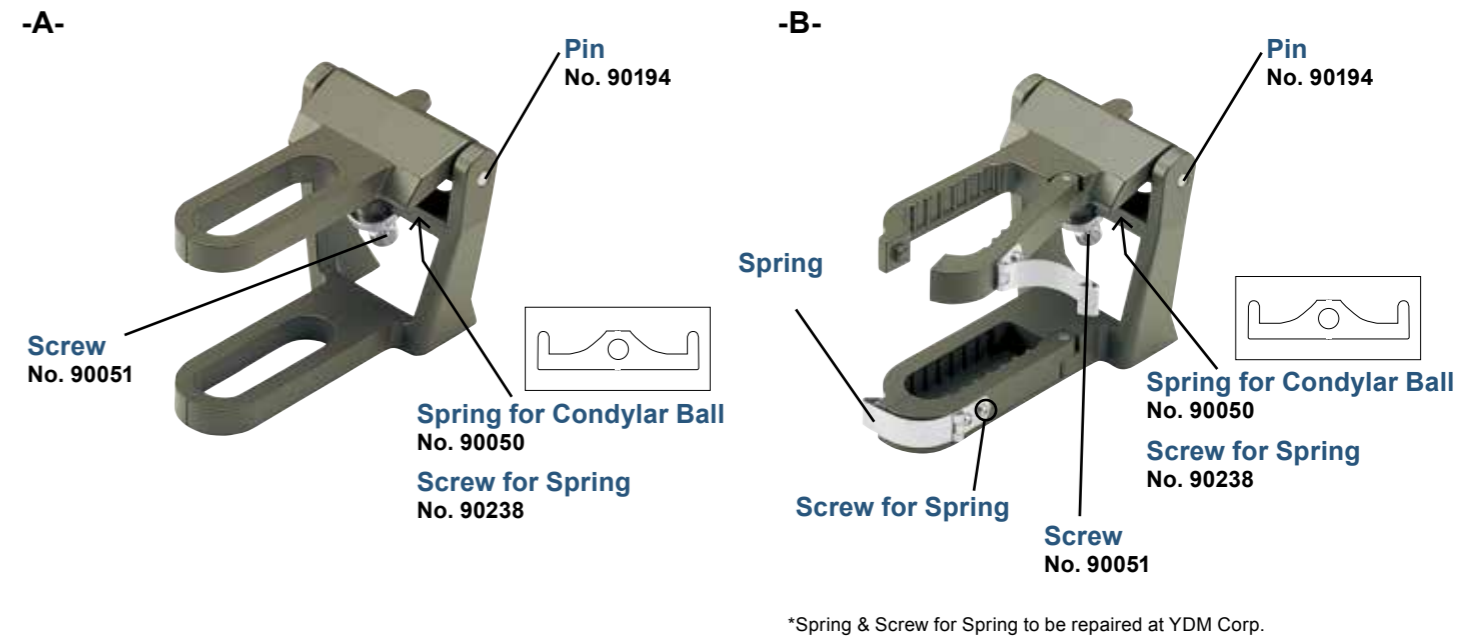

Accessories for Spacy Articulator

-Split Cast Plate A / Split Cast Plate B-

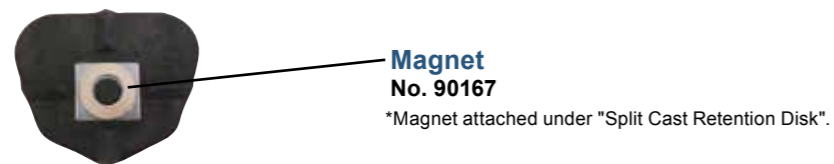

Flask

-Upper / Lower-

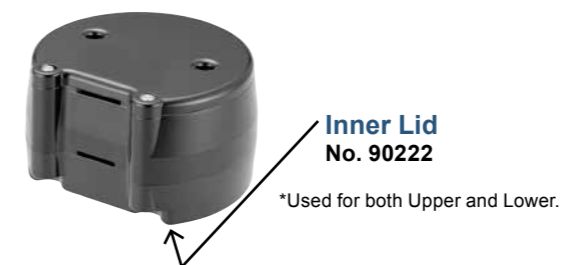

Unity Articulator



Laboratory Calipers

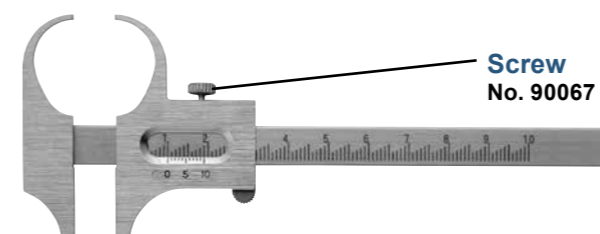

Dental Calipers

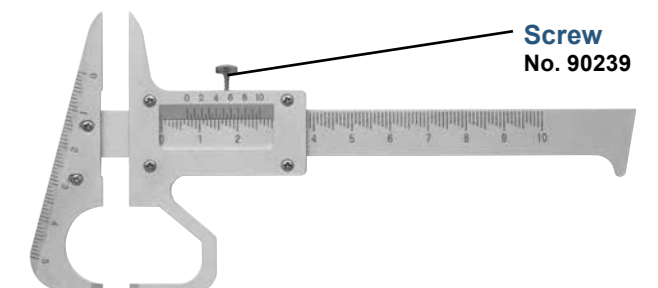



Parallel Meter



Handy Torch

-Labo / Ortho-



Orthodontic Pliers EVER

- Classic 412 / Fine 443-

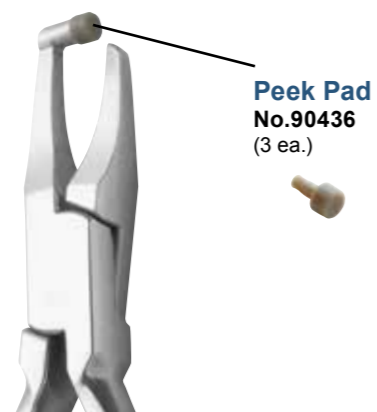

Convertible Cap Removing Pliers

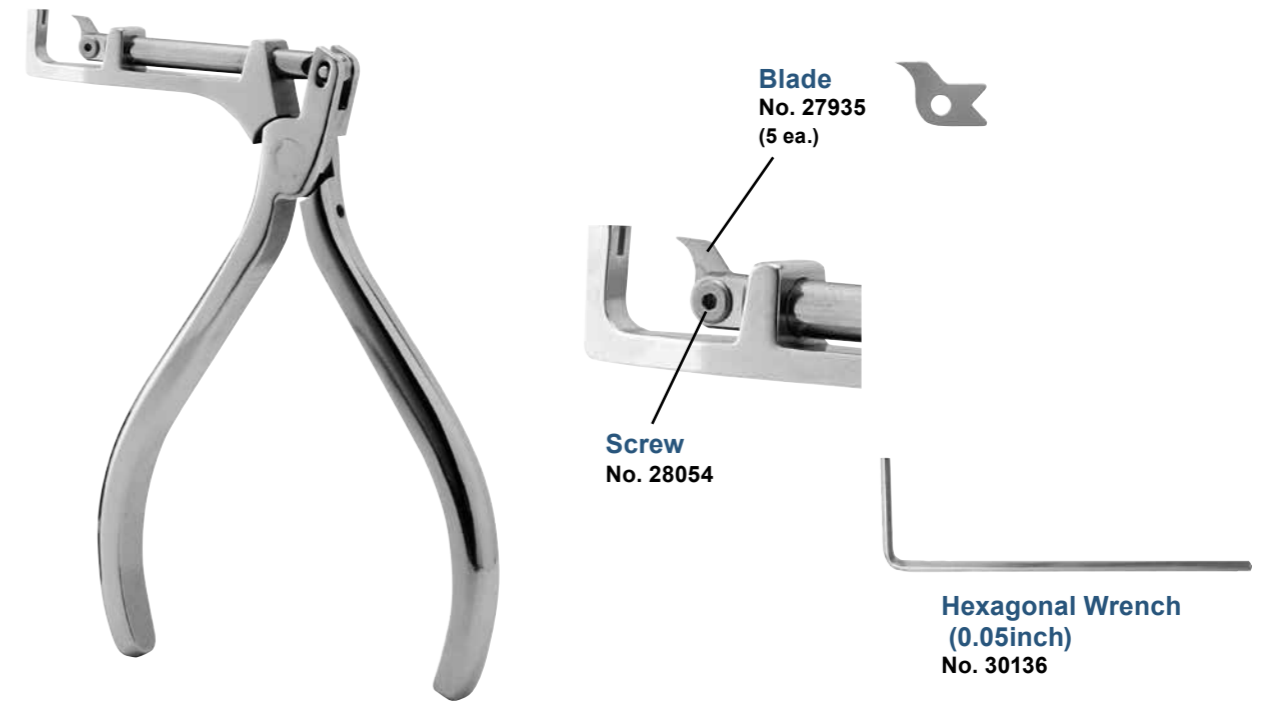

Tying Pliers

-YS-506 / YS-507-

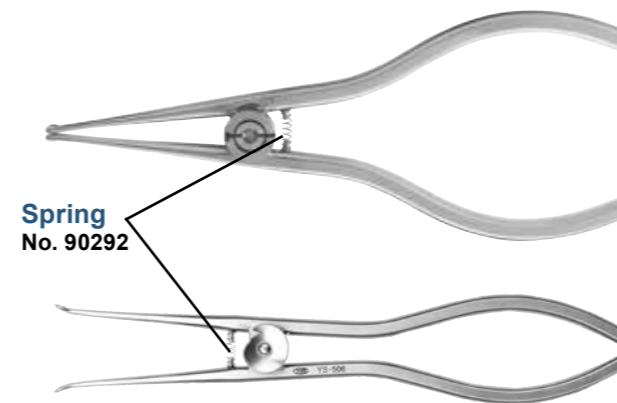

Separator

-YS-551-



Band Seater

-YS-703-





Almighty Mouth Gag

-Adult / Child-

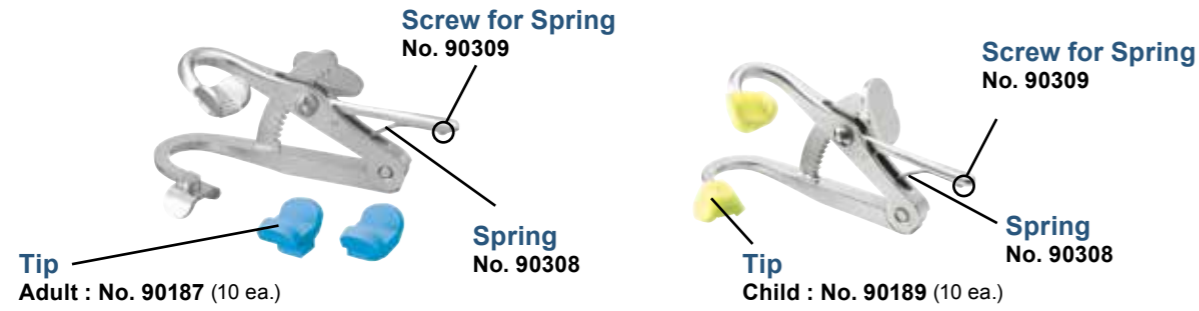

Sterilization Cassette

-Type-A / Type-B -



Photographic Mirror



One-Touch Cotton Box Type-2

-Alcohol-

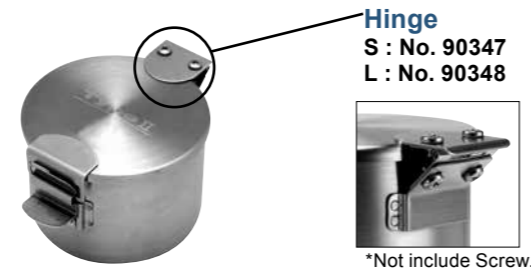

Sterilization Case

-MS #1-

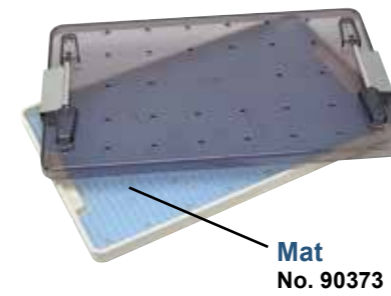

-MS #2-

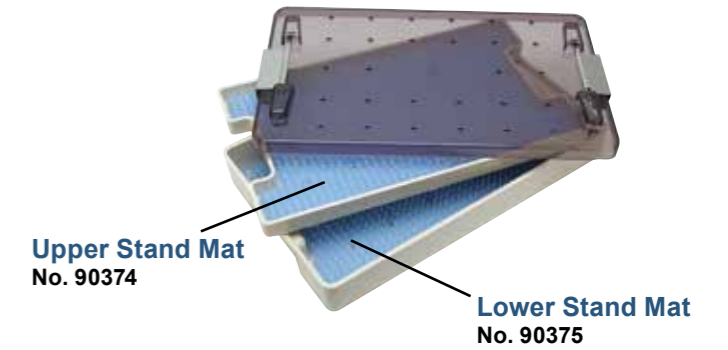

Cotton Dispenser

-Cotton & Gauze / Pellets-

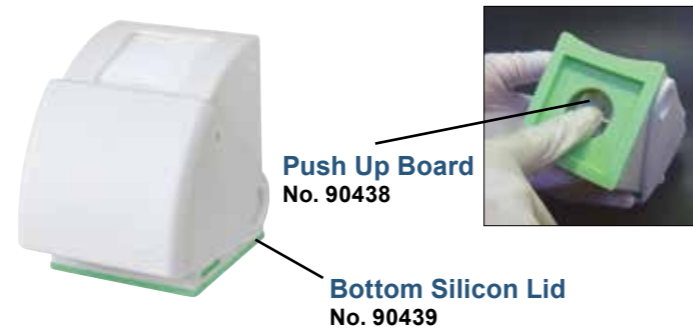

-S Green-

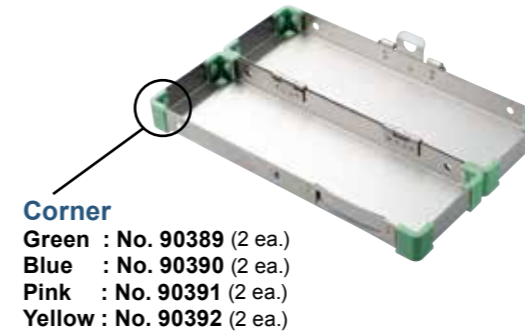

-Free S Green / Free M Green-

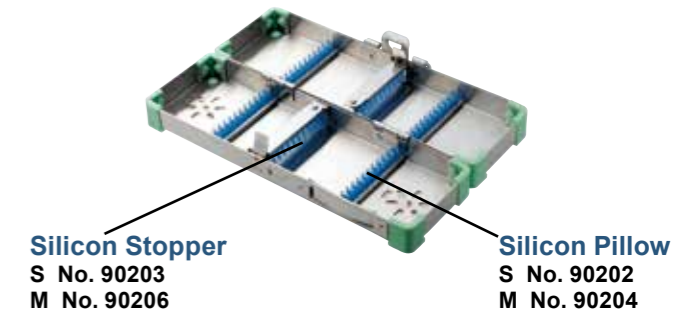

Sterilization Pouch L No. 13270

Size / H250 x W85mm

suitable for

No.	Description
13261	ST Occlusal
13264	ST Occlusal Wide L
13266	ST Occlusal Wide LL
13274	SE Occlusal LL
13282	Crystal Occlusal L
13571	Occlusal
13576	Occlusal Wide L
13578	Occlusal Wide LL

Sterilization Pouch No. 13269

Size / H205 x W80mm

suitable for

No.	Description
13262	ST Lingual
13263	ST Buccal
13265	ST Occlusal Wide S
13271	SE Buccal & Lingual
13272	SE Occlusal L
13273	SE Occlusal M
13281	Crystal Buccal & Lingual
13283	Crystal Occlusal M
13572	Lingual
13573	Buccal
13577	Occlusal Wide S

Phial Stand One-Touch

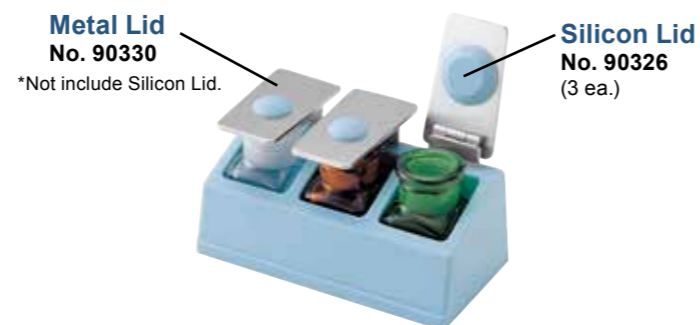

Bur Pot Set

